



CATÁLOGO DE PRODUCTOS

ÍNDICE

Producto

Página

OSTEOSÍNTESIS

TORNILLOS	04
PLACAS 3,5 MM	16
PLACAS 4,5 MM	26
PRÓTESIS	37
CEMENTOS	40
CLAVOS, ALAMBRES Y GRAPAS	42
CLAVOS CENTROMEDULARES	48

FIJADORES

FIJADORES TUBULARES	52
FIJADORES TIPO AO	54
FIJADORES TIPO ORTHOFIX	56
ACCESORIOS PARA FIJADOR	59

LCP

PLACAS BLOQUEADAS 2.4 MM	65
PLACAS BLOQUEADAS 3.5 MM	66
PLACAS BLOQUEADAS 4.9 MM	74
PERNOS DE BLOQUEO	81
TORNILLOS DE TITANIO	88

INSTRUMENTAL

INSTRUMENTAL BÁSICO	93
CAJAS PARA ESTIRILIZAR	110
SETS DE INSTRUMENTAL	112
EQUIPO DE CLAVO CENTROMEDULAR	129
EQUIPOS DE PODER	130
ACCESORIOS PARA EQUIPOS DE PODER	134



WWW.TRAVMAMEDICAL.COM

TORNILLO CORTICAL 3.5 MM AUTORROSCANTE

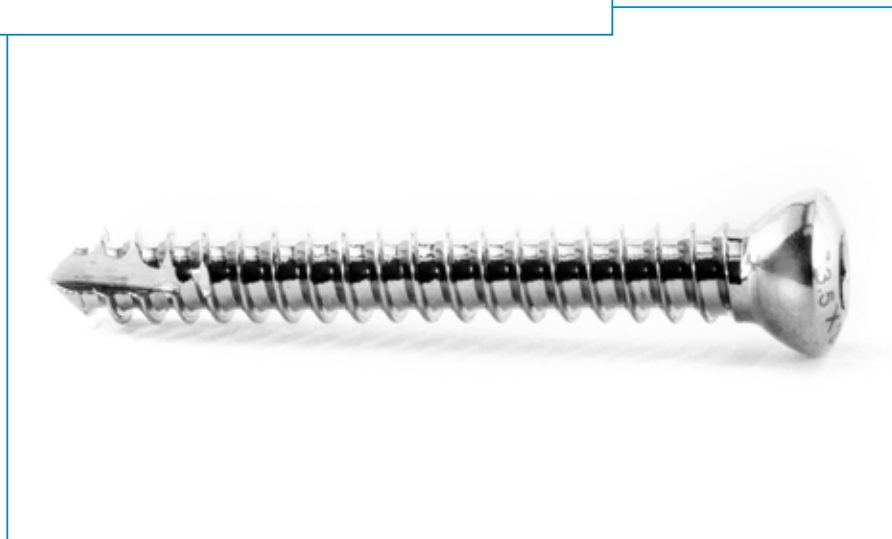
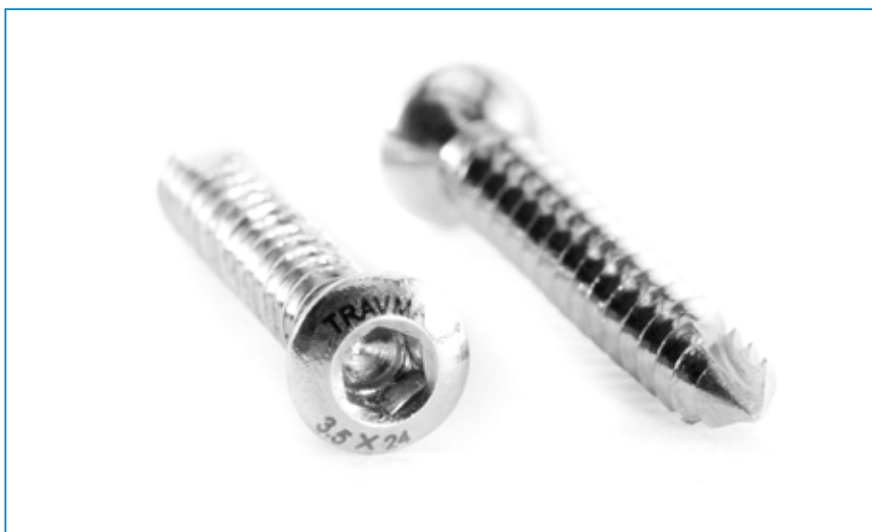

TORNILLO CORTICAL 3.5 MM AUTORROSCANTE		
10 mm	12 mm	14 mm
16 mm	18 mm	20 mm
22 mm	24 mm	26 mm
28 mm	30 mm	32 mm
34 mm	36 mm	38 mm
40 mm	42 mm	44 mm
46 mm	48 mm	50 mm

TORNILLO CORTICAL 4.5 MM AUTORROSCANTE

TORNILLO CORTICAL 4.5 MM AUTORROSCANTE

12 mm	14 mm	16 mm
18 mm	20 mm	22 mm
24 mm	26 mm	28 mm
30 mm	32 mm	34 mm
36 mm	38 mm	40 mm
42 mm	44 mm	46 mm
48 mm	50 mm	52 mm
54 mm	56 mm	58 mm
60 mm	62 mm	64 mm
66 mm	68 mm	70 mm



TORNILLO ESPONJOSO 4.0 MM ROSCA TOTAL

TORNILLO ESPONJOSO 4.0 MM ROSCA TOTAL		
10 mm	12 mm	14 mm
16 mm	18 mm	20 mm
22 mm	24 mm	26 mm
28 mm	30 mm	32 mm
34 mm	36 mm	38 mm
40 mm	42 mm	44 mm
46 mm	48 mm	50 mm

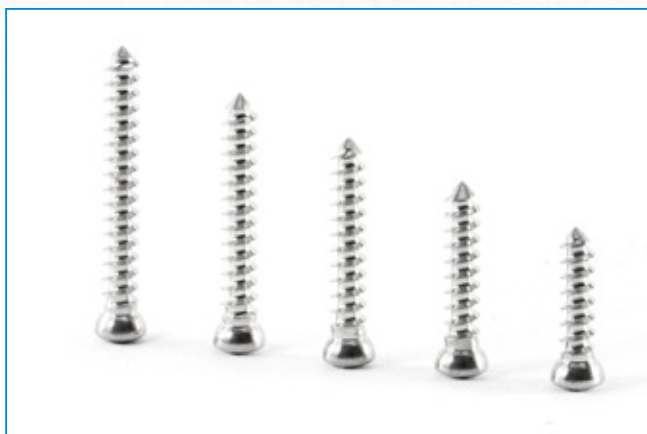

TORNILLO ESPONJOSO 4.0 MM ROSCA PARCIAL

TORNILLO ESPONJOSO 4.0 MM ROSCA PARCIAL		
10 mm	12 mm	14 mm
16 mm	18 mm	20 mm
22 mm	24 mm	26 mm
28 mm	30 mm	32 mm
34 mm	36 mm	38 mm
40 mm	42 mm	44 mm
46 mm	48 mm	50 mm



TORNILLO ESPONJOSO 6.5 MM ROSCA 16



TORNILLO ESPONJOSO 6.5 MM ROSCA 16		
25 mm	30 mm	35 mm
40 mm	45 mm	50 mm
55 mm	60 mm	65 mm
70 mm	75 mm	80 mm
85 mm	90 mm	95 mm
100 mm	105 mm	110 mm

TORNILLO ESPONJOSO 6.5 MM ROSCA 32

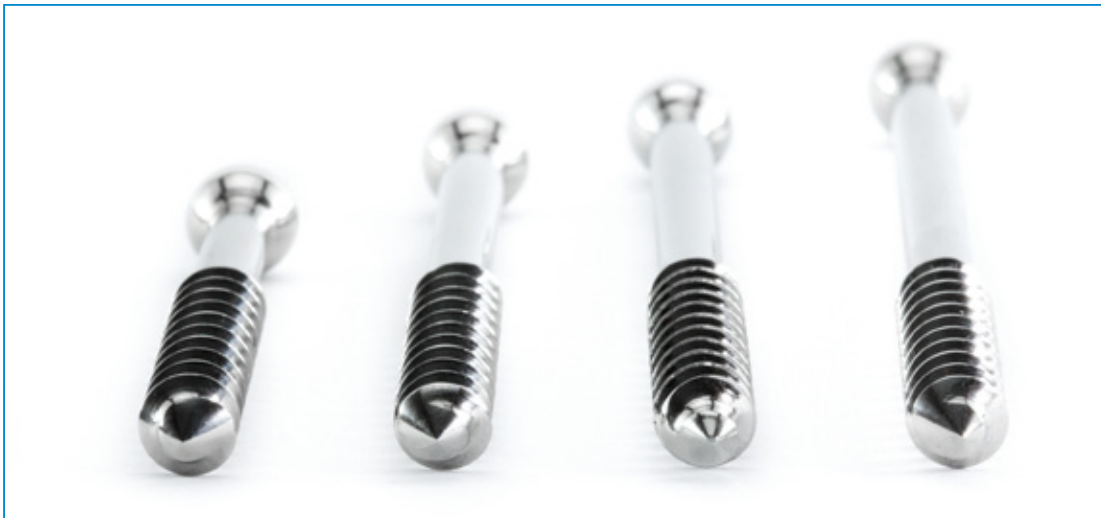

TORNILLO ESPONJOSO 6.5 MM ROSCA 32

40 mm	45 mm	50 mm
55 mm	60 mm	65 mm
70 mm	75 mm	80 mm
85 mm	90 mm	95 mm
100 mm	105 mm	110 mm

TORNILLO ESPONJOSO 6.5 MM ROSCA TOTAL

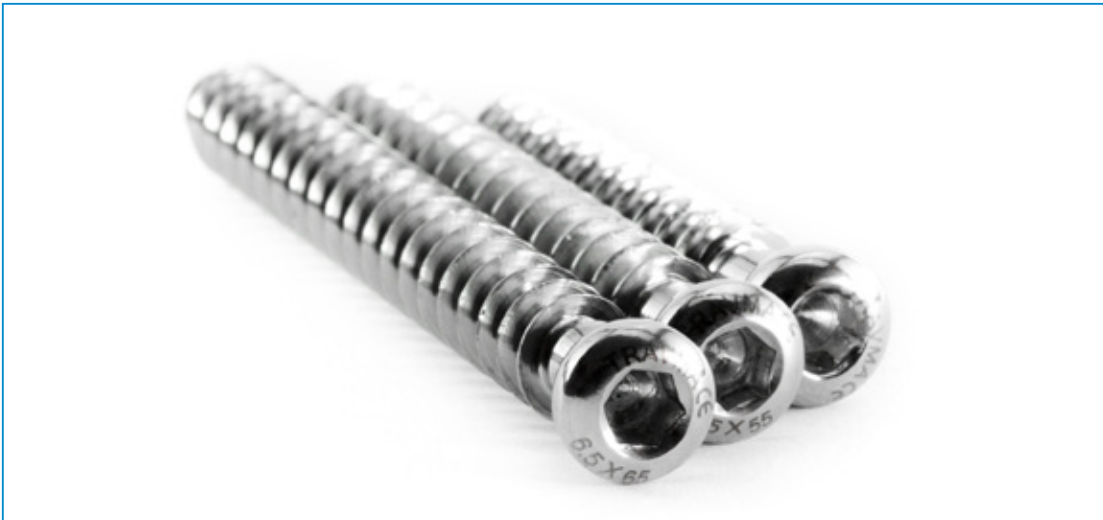

TORNILLO ESPONJOSO 6.5 MM ROSCA TOTAL

25 mm	30 mm	35 mm
40 mm	45 mm	50 mm
55 mm	60 mm	65 mm
70 mm	75 mm	80 mm
85 mm	90 mm	95 mm
100 mm	105 mm	110 mm

TORNILLO CANULADO 4.0 MM ROSCA PARCIAL

TORNILLO CANULADO 4.0 MM ROSCA PARCIAL		
10 mm	12 mm	14 mm
16 mm	18 mm	20 mm
22 mm	24 mm	26 mm
28 mm	30 mm	35 mm
40 mm	45 mm	50 mm
55 mm	60 mm	

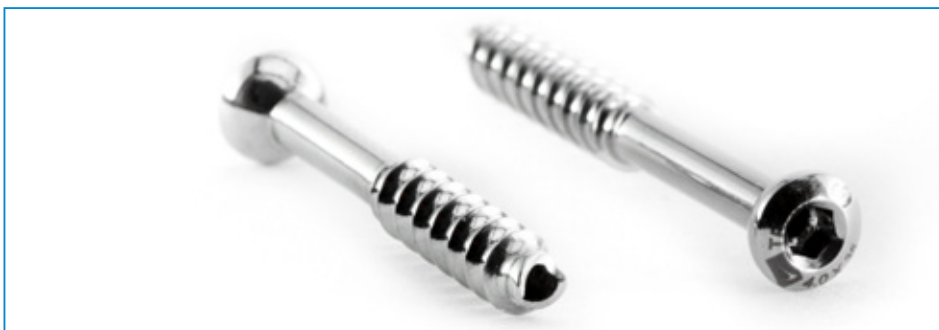

TORNILLO CANULADO 6.5 MM ROSCA 16

TORNILLO CANULADO 6.5 MM ROSCA 16		
25 mm	30 mm	35 mm
40 mm	45 mm	50 mm
55 mm	60 mm	65 mm
70 mm	75 mm	80 mm
85 mm	90 mm	95 mm
100 mm		



TORNILLO CANULADO 6.5 MM ROSCA 32

TORNILLO CANULADO 6.5 MM ROSCA 32		
35 mm	40 mm	45 mm
50 mm	55 mm	60 mm
65 mm	70 mm	75 mm
80 mm	85 mm	90 mm
95 mm	100 mm	

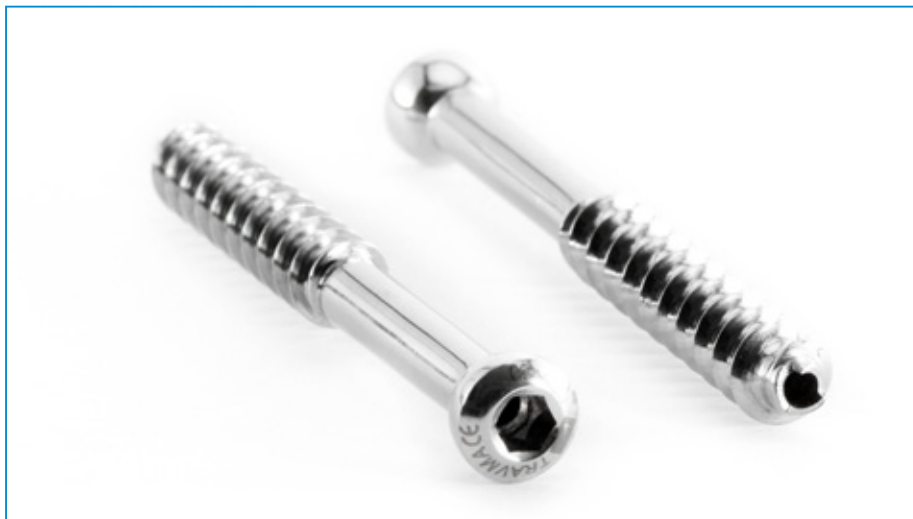

TORNILLO DESLIZANTE DOBLE PARED



TORNILLO DESLIZANTE DOBLE PARED		
50 mm	55 mm	60 mm
65 mm	70 mm	75 mm
80 mm	85 mm	90 mm
95 mm	100 mm	105 mm
110 mm	115 mm	

TORNILLO INTERFERENCIAL TITANIO

TORNILLO INTERFERENCIAL TITANIO		
7X25 mm	8X25 mm	9X25 mm



PLACA SEMITUBULAR 1/3 CAÑA 3.5 MM

PLACA SEMITUBULAR 1/3 DE CAÑA 3.5 MM		
4 orificios	5 orificios	6 orificios
7 orificios	8 orificios	9 orificios
10 orificios	11 orificios	12 orificios
13 orificios	14 orificios	



PLACA PARA CALCÁNEO 3.5 MM

PLACA PARA CALCÁNEO 3.5 MM		
60 mm	70 mm	



PLACA PARA ANTEBRAZO DCP 3.5 MM

PLACA PARA ANTEBRAZO DCP 3.5 MM		
4 orificios	5 orificios	6 orificios
7 orificios	8 orificios	9 orificios
10 orificios	11 orificios	12 orificios
13 orificios	14 orificios	



PLACA PARA ANTEBRAZO LOW CONTACT DCP 3.5 MM

PLACA PARA ANTEBRAZO LOW CONTACT DCP 3.5 MM		
4 orificios	5 orificios	6 orificios
7 orificios	8 orificios	9 orificios
10 orificios	11 orificios	12 orificios



PLACA PARA RECONSTRUCCIÓN CURVA 3.5 MM

PLACA PARA RECONSTRUCCIÓN CURVA 3.5 MM		
4 orificios	5 orificios	6 orificios
7 orificios	8 orificios	9 orificios
10 orificios	11 orificios	12 orificios
13 orificios	14 orificios	



PLACA PARA RECONSTRUCCIÓN 3.5 MM

PLACA PARA RECONSTRUCCIÓN 3.5 MM		
4 orificios	5 orificios	6 orificios
7 orificios	8 orificios	9 orificios
10 orificios	11 orificios	12 orificios
13 orificios	14 orificios	



PLACA GANCHO PARA CLAVÍCULA 3.5 MM

PLACA GANCHO PARA CLAVÍCULA 3.5 MM DERECHA / IZQUIERDA		
4 orificios	5 orificios	6 orificios
7 orificios		



PLACA TRÉBOL 3.5 MM

PLACA TRÉBOL 3.5 MM		
4 orificios	5 orificios	6 orificios
7 orificios	8 orificios	9 orificios
10 orificios	11 orificios	12 orificios
13 orificios	14 orificios	



PLACA EN T PARA RADIO RECTA 3.5 MM

PLACA EN T PARA RADIO RECTA 3.5 MM		
3 x 3	3 x 4	3 x 5
3 x 6		
4 x 3	4 x 4	4 x 5
4 x 6		

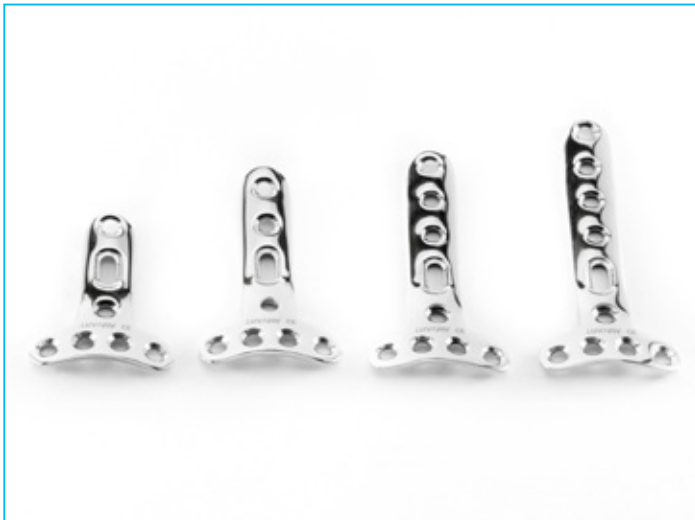

PLACA EN T PARA RADIO OBLICUA BILATERAL 3.5 MM



PLACA EN T PARA RADIO OBLICUA BILATERAL 3.5 MM		
3 x 3	3 x 4	3 x 5
3 x 6	3 x 7	

PLACA LIGERA ANGOSTA DCP 4.5 MM

PLACA LIGERA ANGOSTA DCP 4.5 MM		
5 orificios	6 orificios	7 orificios
8 orificios	9 orificios	10 orificios
11 orificios	12 orificios	13 orificios
14 orificios	15 orificios	16 orificios
17 orificios	18 orificios	



PLACA PESADA ANCHA DCP 4.5 MM

PLACA PESADA ANCHA DCP 4.5 MM		
5 orificios	6 orificios	7 orificios
8 orificios	9 orificios	10 orificios
11 orificios	12 orificios	13 orificios
14 orificios	15 orificios	16 orificios
17 orificios	18 orificios	

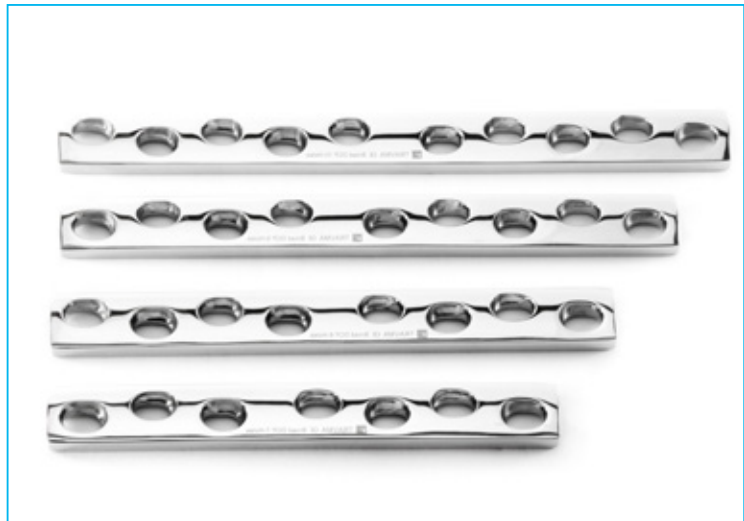

PLACA EN L 4.5 MM

PLACA EN L 4.5 MM DERECHA / IZQUIERDA		
3 orificios	4 orificios	5 orificios
6 orificios	7 orificios	8 orificios
9 orificios	10 orificios	11 orificios
12 orificios	13 orificios	14 orificios



PLACA EN T 4.5 MM

PLACA EN T 4.5 MM		
4 orificios	5 orificios	6 orificios
7 orificios	8 orificios	9 orificios
10 orificios	11 orificios	12 orificios
13 orificios	14 orificios	

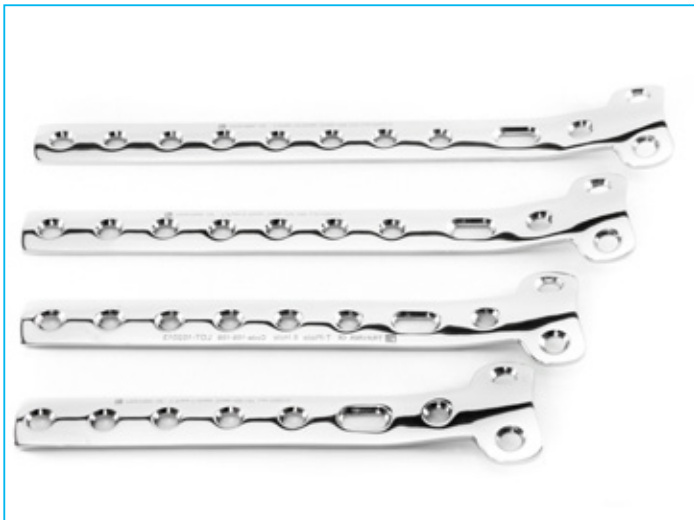

PLACA HOCKEY 4.5 MM

PLACA HOCKEY 4.5 MM DERECHA / IZQUIERDA		
5 orificios	6 orificios	7 orificios
8 orificios	9 orificios	10 orificios
11 orificios	12 orificios	13 orificios

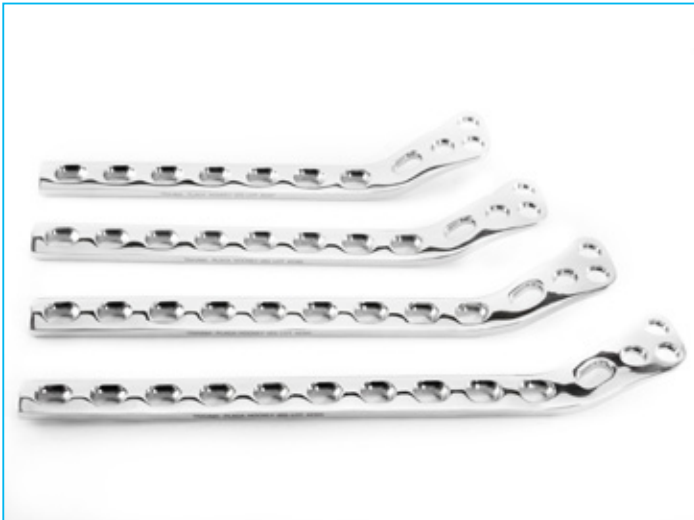

PLACA CONDYLAR BUTTRESS 4.5 MM

PLACA CONDYLAR BUTTRESS 4.5 MM DERECHA / IZQUIERDA		
5 orificios	6 orificios	7 orificios
8 orificios	9 orificios	10 orificios
11 orificios	12 orificios	13 orificios
14 orificios	15 orificios	16 orificios



PLACA CONDYLAR ANGULADA 95°

PLACA CONDYLAR ANGULADA 95°		
5 orificios / hoja 50 mm	5 orificios / hoja 60 mm	5 orificios / hoja 70 mm
5 orificios / hoja 80 mm	5 orificios / hoja 90 mm	
7 orificios / hoja 50 mm	7 orificios / hoja 60 mm	7 orificios / hoja 70 mm
7 orificios / hoja 80 mm	7 orificios / hoja 90 mm	
9 orificios / hoja 50 mm	9 orificios / hoja 60 mm	9 orificios / hoja 70 mm
9 orificios / hoja 80 mm	9 orificios / hoja 90 mm	
12 orificios / hoja 50 mm	12 orificios / hoja 60 mm	12 orificios / hoja 70 mm
12 orificios / hoja 80 mm	12 orificios / hoja 90 mm	
14 orificios / hoja 50 mm	14 orificios / hoja 60 mm	14 orificios / hoja 70 mm
14 orificios / hoja 80 mm	14 orificios / hoja 90 mm	
16 orificios / hoja 50 mm	16 orificios / hoja 60 mm	16 orificios / hoja 70 mm
16 orificios / hoja 80 mm	16 orificios / hoja 90 mm	
18 orificios / hoja 50 mm	18 orificios / hoja 60 mm	18 orificios / hoja 70 mm
18 orificios / hoja 80 mm	18 orificios / hoja 90 mm	



PLACA PERTROCANTÉRICA ANGULADA 130°

PLACA PERTROCANTÉRICA ANGULADA 130°		
4 orificios / hoja 50 mm	4 orificios / hoja 60 mm	4 orificios / hoja 70 mm
4 orificios / hoja 80 mm	4 orificios / hoja 90 mm	
6 orificios / hoja 50 mm	6 orificios / hoja 60 mm	6 orificios / hoja 70 mm
6 orificios / hoja 80 mm	6 orificios / hoja 90 mm	
9 orificios / hoja 50 mm	9 orificios / hoja 60 mm	9 orificios / hoja 70 mm
9 orificios / hoja 80 mm	9 orificios / hoja 90 mm	
12 orificios / hoja 50 mm	12 orificios / hoja 60 mm	12 orificios / hoja 70 mm
12 orificios / hoja 80 mm	12 orificios / hoja 90 mm	
14 orificios / hoja 50 mm	14 orificios / hoja 60 mm	14 orificios / hoja 70 mm
14 orificios / hoja 80 mm	14 orificios / hoja 90 mm	



PLACA DCS DOBLE PARED 95°

PLACA DCS DOBLE PARED 95°		
4 orificios	5 orificios	6 orificios
7 orificios	8 orificios	9 orificios
10 orificios	11 orificios	12 orificios
13 orificios	14 orificios	15 orificios
16 orificios		



PLACA DHS DOBLE PARED 135°

PLACA DHS DOBLE PARED 135°		
4 orificios	5 orificios	6 orificios
7 orificios	8 orificios	9 orificios
10 orificios	11 orificios	12 orificios
13 orificios	14 orificios	15 orificios
16 orificios		



PLACA DHS 135° DOBLE PARED BARRIL CORTO

PLACA DHS 135 ° DOBLE PARED BARRIL CORTO		
4 orificios	5 orificios	6 orificios
7 orificios	8 orificios	



PRÓTESIS DE THOMPSON

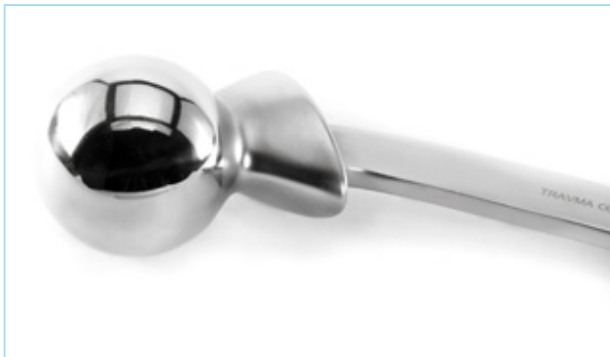

PRÓTESIS DE THOMPSON		
36 mm	38 mm	40 mm
42 mm	44 mm	46 mm
48 mm	50 mm	52 mm
54 mm		

PRÓTESIS DE AUSTIN MOORE



PRÓTESIS DE AUSTIN MOORE		
38 mm	39 mm	40 mm
41 mm	42 mm	43 mm
44 mm	45 mm	46 mm
47 mm	48 mm	49 mm
50 mm	51 mm	

PRÓTESIS DE LAZCANO



PRÓTESIS DE LAZCANO		
36 mm	38 mm	40 mm
42 mm	44 mm	46 mm
48 mm	50 mm	52 mm
54 mm		



Marca EUROFIX

Cemento Simple 40 gramos

Cemento con Gentamicina
40 gramos

Cemento VTP
25 gramos

Kit de Aplicación VTP

CEMENTO



MARCA DEPUY

Cemento Simple 40 gramos

Cemento con Gentamicina 40 gramos

CLAVO DE STEINMAN

CLAVO DE STEINMAN		
3/32" 2.4 mm	7/64" 2.8 mm	1/8" 3.2 mm
9/64" 3.6 mm	5/32" 4.0 mm	3/16" 4.8 mm
1/4" 6.3 mm		



ALAMBRE DE KIRSCHNER

ALAMBRE DE KIRSCHNER 25 CM			
0.035" 0.9 mm	0.045" 1.1 mm	0.062" 1.6 mm	5/64" 2.0 mm



ALAMBRE GUÍA PUNTA ROSCADA

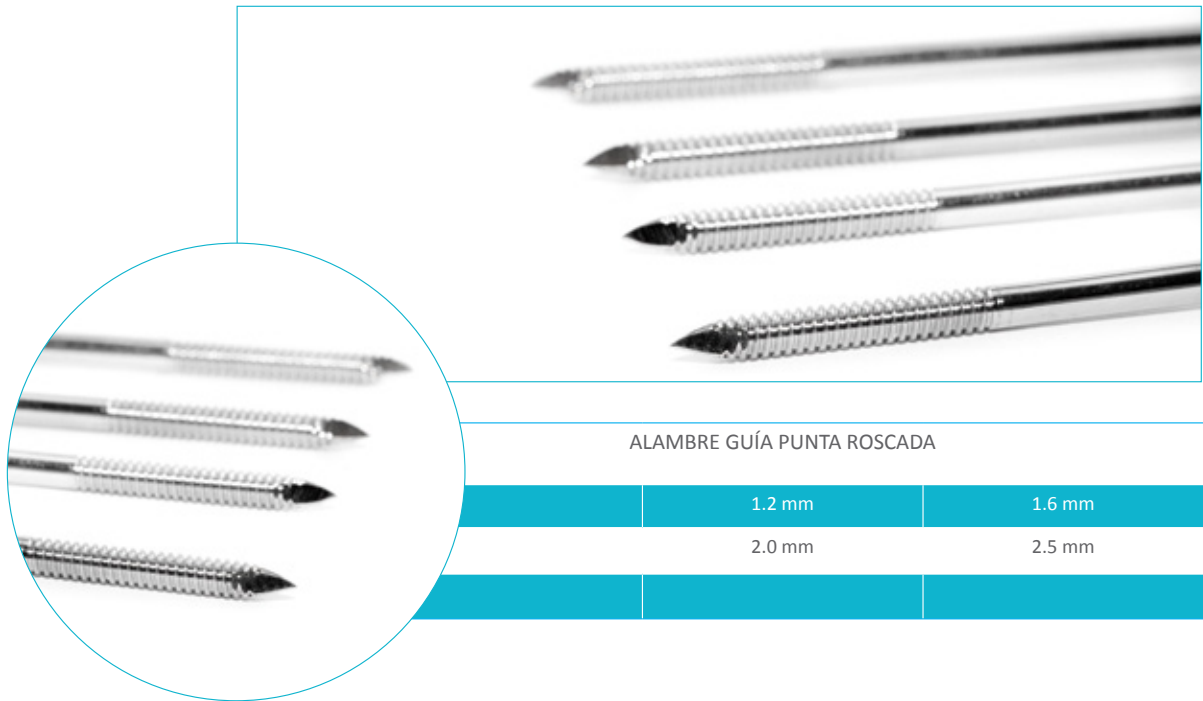

ALAMBRE GUÍA PUNTA ROSCADA

	1.2 mm	1.6 mm
	2.0 mm	2.5 mm

CLAVO CON ROSCA INTERMEDIA



CLAVO CON ROSCA INTERMEDIA

	1/8" 3.2 mm	5/32" 4.0 mm
	3/16" 4.8 mm	1/4" 6.3 mm

CLAVO DE SCHANZ

CLAVO DE SCHANZ		
3/32" R20 fina 2.4 15 cms	7/64" R20 2.8 15 cms	1/8 " R20 3.2 15 cms
5/32" R32 4.0 21 cms	3/16" R32 4.8 21 cms	Tipo Orthofix 6.0 21 cms
5/32" p/mini fijador desbaste 2.7 (7 cms aprox)	5/32" p/mini fijador desbaste 3.2 (8 cms aprox)	
5/32" p/fijador de Colles desbaste 2.7 (15 cms aprox)	5/32" p/fijador de Colles desbaste 3.2 (15 cms aprox)	

CLAVO DE SCHANZ AUTORROSCANTES		
2.4 mm / 15 cms	2.8 mm / 15 cms	3.2 mm / 15 cms
4.0 mm / 21 cms	4.8 mm / 21 cms	5.0 mm / 21 cms
6.0 mm / 21 cms		



CLAVO TEN EN TITANIO

CLAVO TEN EN TITANIO		
	2.0 MM	
	2.5 MM	
	3.0 MM	
	3.5 MM	
	4.0 MM	

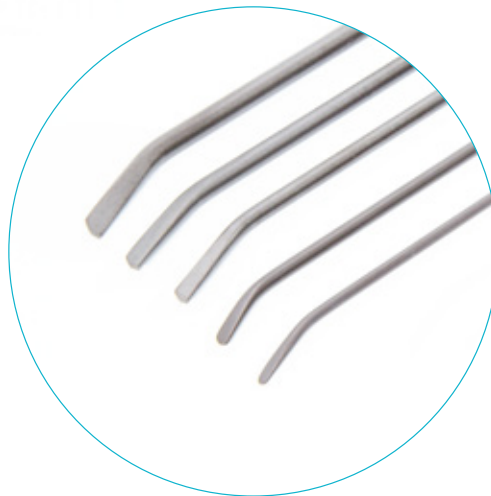

ARANDELAS Y GRAPAS



ARANDELAS	
Arandela para tornillo 3.5 y 4.0	
Arandela para tornillo 4.5 y 6.5	

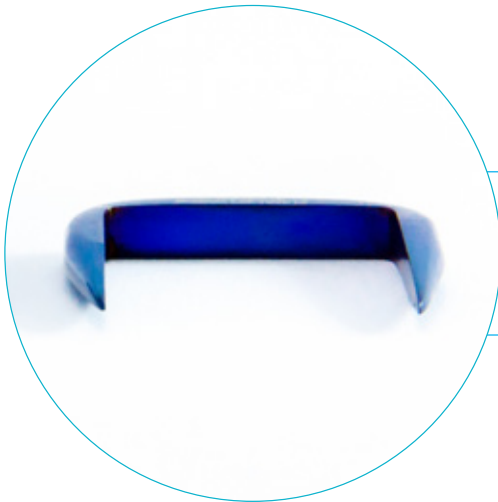

GRAPA DE BLOUNT		
	1/2 " (12.5 mm)	5/8 " (16 mm)
3/4 " (20mm)	1" (25 mm)	1 y 1/2" (30 mm)



GRAPA DE COVENTRY		
	3/4" (20 mm)	1" (25 mm)
	1 1/4" (30 mm)	1 y 1/2" (35 mm)

ALAMBRE DE CERCLAJE

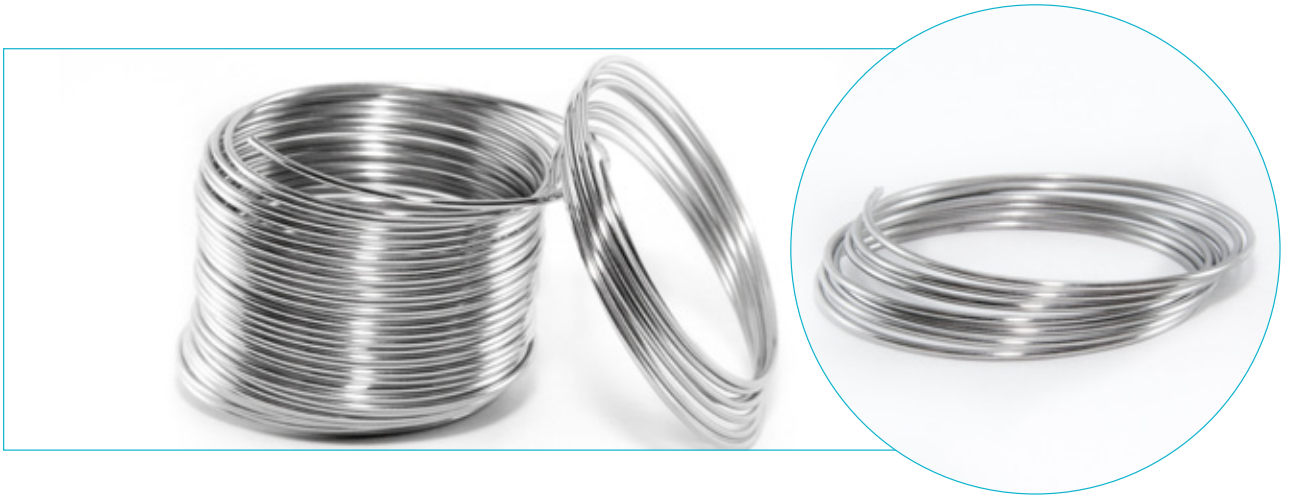

ALAMBRE DE CERCLAJE			
1.0 mm x 1 mt	1.0 mm x 3 mt	1.0 mm x 5 mt	1.0 mm x 10 mt
1.2 mm x 1 mt	1.2 mm x 3 mt	1.2 mm x 5 mt	1.2 mm x 10 mt
1.6 mm x 5 mt	1.6 mm x 10 mt		

CLAVO CENTROMEDULAR PARA HÚMERO

CLAVO CENTROMEDULAR CANULADO PARA HÚMERO		
TITANIO		
7X180 mm	7X200 mm	7X220 mm
7X240 mm	7X260 mm	7X280 mm
8X180 mm	8X200 mm	8X220 mm
8X240 mm	8X260 mm	8X280 mm



CLAVO CENTROMEDULAR PARA TIBIA

CLAVO CENTROMEDULAR CANULADO PARA TIBIA					
ACERO			TITANIO		
8X240 mm	8X260 mm	8X280 mm	8X240 mm	8X260 mm	8X280 mm
8X300 mm	8X320 mm	8X340 mm	8X300 mm	8X320 mm	8X340 mm
9X260 mm	9X280 mm	9X300 mm	9X260 mm	9X280 mm	9X300 mm
9X320 mm	9X340 mm	9X360 mm	9X320 mm	9X340 mm	9X360 mm
10X280 mm	10X300 mm	10X320 mm	10X280 mm	10X300 mm	10X320 mm
10X340 mm	10X360 mm	10X380 mm	10X340 mm	10X360 mm	10X380 mm



CLAVO CENTROMEDULAR PARA FÉMUR

CLAVO CENTROMEDULAR CANULADO PARA FÉMUR					
ACERO			TITANIO		
9X320 mm	9X340 mm	9X360 mm	9X320 mm	9X340 mm	9X360 mm
9X380 mm	9X400 mm		9X380 mm	9X400 mm	
10X320 mm	10X340 mm	10X360 mm	10X320 mm	10X340 mm	10X360 mm
10X380 mm	10X400 mm	10X420 mm	10X380 mm	10X400 mm	10X420 mm
11X340 mm	11X360 mm	11X380 mm	11X340 mm	11X360 mm	11X380 mm
11X400 mm	11X420 mm		11X400 mm	11X420 mm	





En Tragma Medical contamos con un exigente sistema de procedimientos con el objetivo de mantener un alto nivel de satisfacción en los productos y servicios que ofrecemos a nuestros clientes.

FIJADORES TUBULARES



FIJADOR PARA DEDO

Fijador para Dedo



FIJADOR PARA MUÑECA / COLLES

Fijador para
Muñeca / Colles

FIJADORES TUBULARES



FIJADOR TIBIA / HÚMERO

Fijador Tibia / Húmero
1 Barra

Fijador Tibia / Húmero
2 Barras



FIJADOR FÉMUR 1 BARRA

Fijador Fémur 1 Barra

FIJADORES TUBULARES

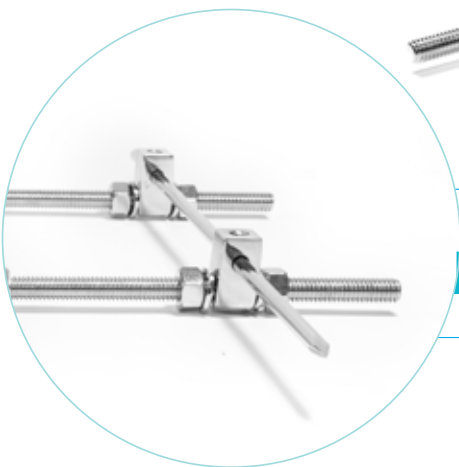
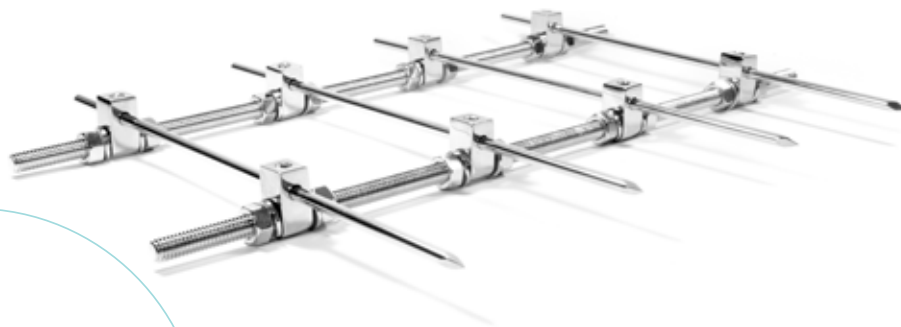

FIJADOR CHARNLEY

Fijador Charnley

FIJADORES TIPO AO

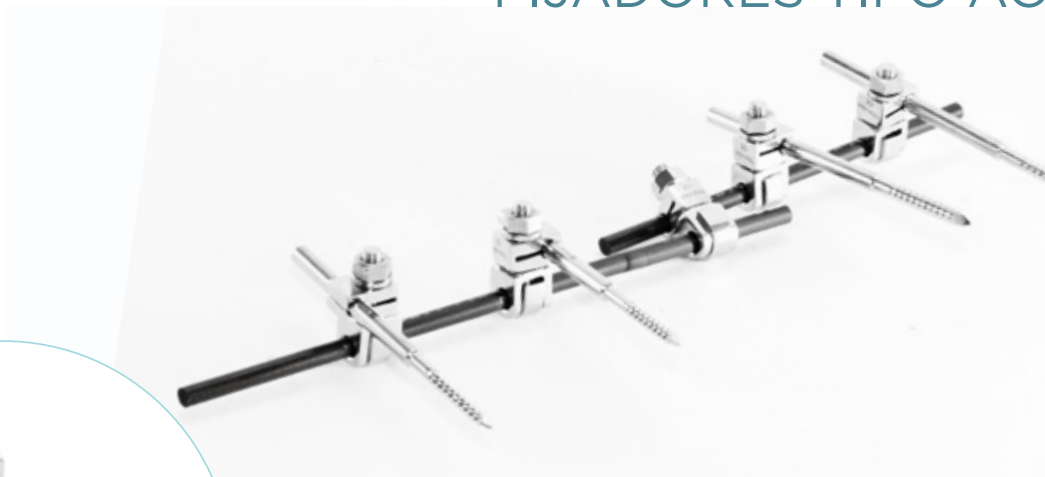

MINIFIJADOR PARA COLLES TIPO AO

Minifijador para Colles tipo
AO barras de acero

Minifijador para Colles tipo
AO barras de carbono

Minifijador para Colles tipo
AO barras de titanio

FIJADORES TIPO AO

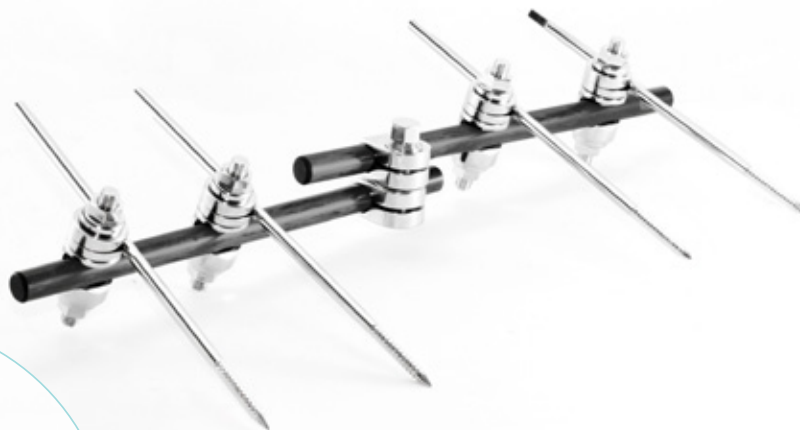

FIJADOR TIBIA / HÚMERO CARBONO

Fijador tibia/húmero con barras de carbono, (4 tubo-clavo, 1 tubo/tubo, 2 barras)



FIJADOR FÉMUR

Fijador Fémur (6 tubo/clavo, 1 barra)

FIJADORES TIPO ORTHOFIX

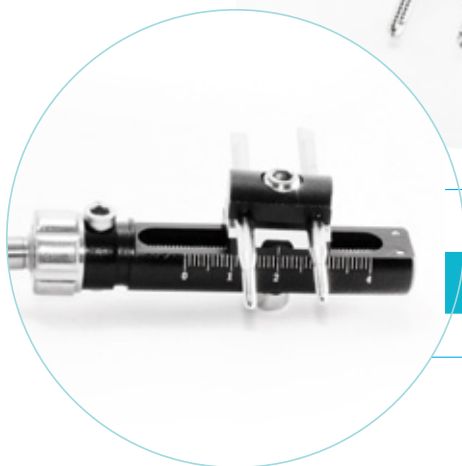

FIJADOR ARTICULADO PARA MUÑECA TIPO ORTHOFIX

Fijador Articulado para Muñeca tipo Orthofix 21 cm
--



FIJADOR RECTO TIPO ORTHOFIX

Fijador Recto tipo Orthofix Chico 20 cm	Fijador Recto tipo Orthofix Mediano 25 cm
---	---

Fijador Recto tipo Orthofix Grande 28 cm
--

FIJADORES TIPO ORTHOFIX

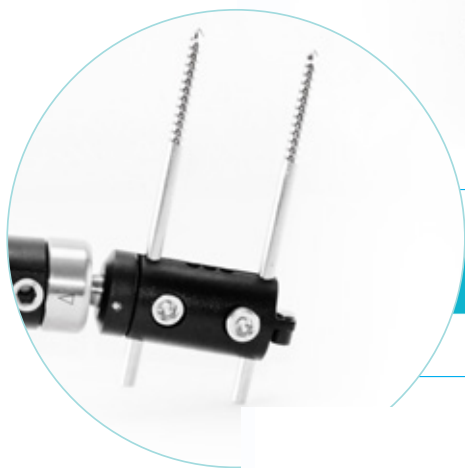

FIJADOR EN T TIPO ORTHOFIX

Fijador en T tipo Orthofix
Extra chico 14 cm

Fijador en T tipo Orthofix
Chico 17 cm

Fijador en T tipo Orthofix
Mediano 20 cm

Fijador en T tipo Orthofix
Grande 25 cm



FIJADOR PARA CODO TIPO ORTHOFIX

Fijador para Codo tipo
Orthofix

FIJADORES TIPO ORTHOFIX



FIJADOR PARA RODILLA TIPO ORTHOFIX

Fijador para Rodilla tipo Orthofix



FIJADOR PARA PELVIS TIPO ORTHOFIX



Fijador para Pelvis tipo Orthofix

FIJADORES TIPO ORTHOFIX

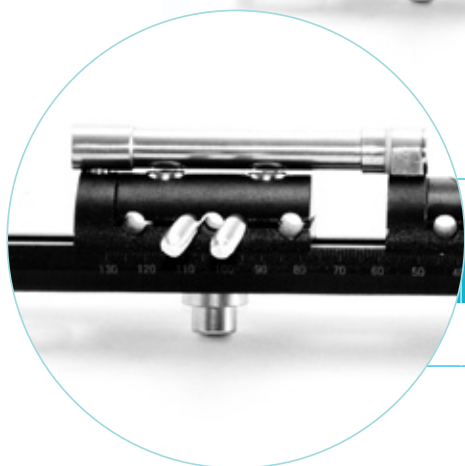

REGLETA ELONGADORA

Regleta Elongadora con 2 dispositivos 30 cm	Regleta Elongadora con 2 dispositivos 35 cm	Regleta Elongadora con 2 dispositivos 40 cm
Regleta Elongadora con 3 dispositivos 30 cm	Regleta Elongadora con 3 dispositivos 35 cm	Regleta Elongadora con 3 dispositivos 40 cm

ACCESORIOS PARA FIJADOR



BARRAS 4.0 MM

FIBRA DE CARBONO	ACERO	TITANIO
10 mm	10 mm	10 mm
15 mm	15 mm	15 mm

ACCESORIOS PARA FIJADOR



BARRAS DE ACERO

	9.5 x 150 mm	9.5 x 200 mm
	9.5 x 250 mm	9.5 x 300 mm
	9.5 x 350 mm	9.5 x 400 mm



BARRAS DE FIBRA DE CARBONO

	11 x150 mm	11 x200 mm
	11 x250 mm	11 x300 mm
	11 x350 mm	11 x400 mm

ACCESORIOS PARA FIJADOR



MINI RÓTULA DE ACERO TIPO AO

Mini Rótula acero tipo AO
P/4mm
(tubo-tubo y tubo-clavo)



RÓTULA TUBO-CLAVO TIPO AO

Rótula Clip On tipo AO
acero P/11mm
(tubo-clavo)

ACCESORIOS PARA FIJADOR



CANDADO TUBO-TUBO TIPO AO

Candado Tubo-Tubo tipo AO
en acero P/11 mm



RÓTULA UNIVERSAL EN ALUMINIO

Rótula Universal en
Aluminio P/9.5 mm
(tubo-clavo)

ACCESORIOS PARA FIJADOR



CANDADO TUBO-TUBO EN ALUMINIO

Candado Tubo-Tubo en Aluminio P/9.5m m (tubo-tubo)



RÓTULA TRANSVERSAL PARA TIBIA

Rótula Transversal para tibia en Acero



*En Tragma medical nos esforzamos para ofrecerle únicamente productos que cumplan los más altos estándares de calidad en materia prima y fabricación.
Certificados por:*



PLACA RADIO DISTAL LCP VOLAR 2.4 MM



PLACA RADIO DISTAL LCP VOLAR 2.4 MM

ACERO		TITANIO	
DERECHA	IZQUIERDA	DERECHA	IZQUIERDA
2 Orif	2 Orif	2 Orif	2 Orif
3 Orif	3 Orif	3 Orif	3 Orif
4 Orif	4 Orif	4 Orif	4 Orif
5 Orif	5 Orif	5 Orif	5 Orif
6 Orif	6 Orif	6 Orif	6 Orif
7 Orif	7 Orif	7 Orif	7 Orif
8 Orif	8 Orif	8 Orif	8 Orif

PLACA SEMITUBULAR 1/3 DE CAÑA LCP 3.5 MM



PLACA SEMITUBULAR 1/3 DE CAÑA LCP 3.5 MM

ACERO	TITANIO
5 Orificios	5 Orificios
6 Orificios	6 Orificios
7 Orificios	7 Orificios
8 Orificios	8 Orificios
9 Orificios	9 Orificios

PLACA ANTEBRAZO LCP 3.5 MM

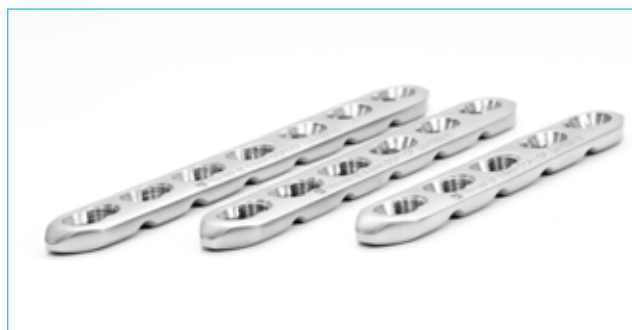

PLACA ANTEBRAZO LCP 3.5 MM

ACERO	TITANIO
5 Orificios	5 Orificios
6 Orificios	6 Orificios
7 Orificios	7 Orificios
8 Orificios	8 Orificios
9 Orificios	9 Orificios
10 Orificios	10 Orificios
12 Orificios	12 Orificios

PLACA DE RECONSTRUCCIÓN LCP 3.5 MM



PLACA DE RECONSTRUCCIÓN LCP 3.5 MM

ACERO	TITANIO
5 Orificios	5 Orificios
6 Orificios	6 Orificios
7 Orificios	7 Orificios
8 Orificios	8 Orificios
9 Orificios	9 Orificios
10 Orificios	10 Orificios
12 Orificios	12 Orificios

PLACA EN T OBLICUA LCP 3.5 MM



PLACA EN T OBLICUA LCP 3.5 MM	
ACERO	TITANIO
3x3	3x3
3x4	3x4
3x5	3x5
3x6	3x6

PLACA EN T PARA RADIO RECTA LCP 3.5 MM



PLACA EN T PARA RADIO RECTA LCP 3.5 MM

ACERO		TITANIO	
3x3	4x3	3x3	4x3
3x4	4x4	3x4	4x4
3x5	4x5	3x5	4x5
3x6		3x6	

PLACA HÚMERO PROXIMAL LCP 3.5 MM



PLACA HÚMERO PROXIMAL LCP 3.5 MM

ACERO	TITANIO
4 Orificios	4 Orificios
5 Orificios	5 Orificios
6 Orificios	6 Orificios
7 Orificios	7 Orificios
8 Orificios	8 Orificios
9 Orificios	9 Orificios
10 Orificios	10 Orificios

PLACA OLECRANÓN LCP 3.5 MM



PLACA OLECRANÓN LCP 3.5 MM

ACERO		TITANIO	
DERECHA	IZQUIERDA	DERECHA	IZQUIERDA
4 Orificios	4 Orificios	4 Orificios	4 Orificios
5 Orificios	5 Orificios	5 Orificios	5 Orificios
6 Orificios	6 Orificios	6 Orificios	6 Orificios
7 Orificios	7 Orificios	7 Orificios	7 Orificios
8 Orificios	8 Orificios	8 Orificios	8 Orificios

PLACA TIBIA DISTAL LCP 2.7/3.5 MM



PLACA TIBIA DISTAL LCP 2.7/3.5 MM			
ACERO		TITANIO	
DERECHA	IZQUIERDA	DERECHA	IZQUIERDA
6 Orificios	6 Orificios	6 Orificios	6 Orificios
7 orificios	7 orificios	7 orificios	7 orificios
8 Orificios	8 Orificios	8 Orificios	8 Orificios
9 orificios	9 orificios	9 orificios	9 orificios
10 Orificios	10 Orificios	10 Orificios	10 Orificios
12 orificios	12 orificios	12 orificios	12 orificios

PLACA LIGERA LCP 4.9 MM



PLACA LIGERA LCP 4.9 MM

ACERO	TITANIO
5 Orificios	5 Orificios
6 Orificios	6 Orificios
7 Orificios	7 Orificios
8 Orificios	8 Orificios
9 Orificios	9 Orificios
10 Orificios	10 Orificios
12 Orificios	12 Orificios
14 Orificios	14 Orificios

PLACA PESADA LCP 4.9 MM



PLACA PESADA LCP 4.9 MM	
ACERO	TITANIO
5 Orificios	5 Orificios
6 Orificios	6 Orificios
7 Orificios	7 Orificios
8 Orificios	8 Orificios
9 Orificios	9 Orificios
10 Orificios	10 Orificios
12 Orificios	12 Orificios
14 Orificios	14 Orificios
16 Orificios	16 Orificios

PLACA EN L LCP 4.9 MM



PLACA EN L LCP 4.9 MM

ACERO		TITANIO	
DERECHA	IZQUIERDA	DERECHA	IZQUIERDA
5 orificios	5 orificios	5 orificios	5 orificios
6 Orificios	6 Orificios	6 Orificios	6 Orificios
7 orificios	7 orificios	7 orificios	7 orificios
8 Orificios	8 Orificios	8 Orificios	8 Orificios
9 orificios	9 orificios	9 orificios	9 orificios

PLACA EN T LCP 4.9 MM



PLACA EN T LCP 4.9 MM

ACERO	TITANIO
5 Orificios	5 Orificios
6 Orificios	6 Orificios
7 Orificios	7 Orificios
8 Orificios	8 Orificios
9 Orificios	9 Orificios

PLACA FÉMUR DISTAL LCP 4.9 MM



PLACA FÉMUR DISTAL LCP 4.9 MM

ACERO		TITANIO	
DERECHA	IZQUIERDA	DERECHA	IZQUIERDA
5 Orificios	5 Orificios	5 Orificios	5 Orificios
7 Orificios	7 Orificios	7 Orificios	7 Orificios
9 Orificios	9 Orificios	9 Orificios	9 Orificios
11 Orificios	11 Orificios	11 Orificios	11 Orificios
13 Orificios	13 Orificios	13 Orificios	13 Orificios

PLACA FÉMUR PROXIMAL LCP 4.9 MM

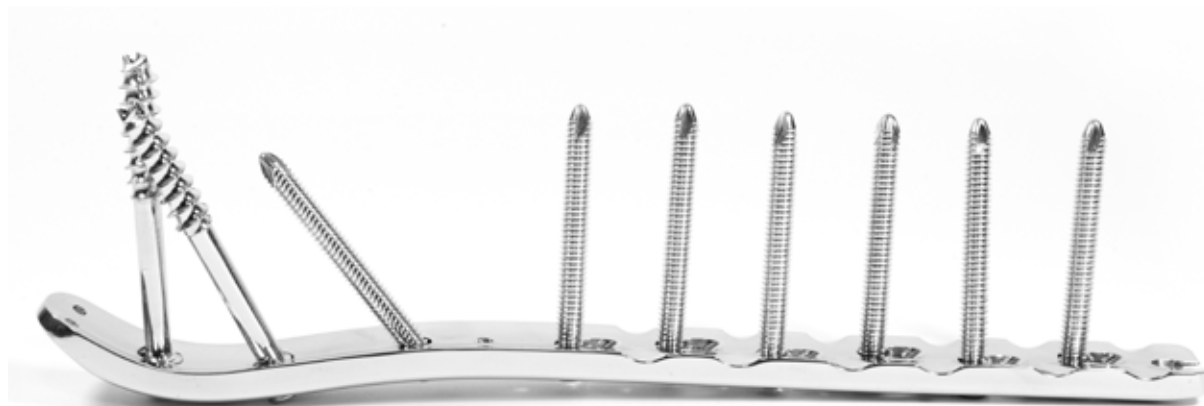

PLACA FÉMUR PROXIMAL LCP 4.9 MM

ACERO		TITANIO	
DERECHA	IZQUIERDA	DERECHA	IZQUIERDA
4 Orificios	4 Orificios	4 Orificios	4 Orificios
5 Orificios	5 Orificios	5 Orificios	5 Orificios
6 Orificios	6 Orificios	6 Orificios	6 Orificios
8 Orificios	8 Orificios	8 Orificios	8 Orificios
10 Orificios	10 Orificios	10 Orificios	10 Orificios
12 Orificios	12 Orificios	12 Orificios	12 Orificios

PLACA TIBIA LATERAL LCP 4.9 MM



PLACA TIBIA LATERAL LCP 4.9 MM			
ACERO		TITANIO	
DERECHA	IZQUIERDA	DERECHA	IZQUIERDA
6 Orificios	6 Orificios	6 Orificios	6 Orificios
7 orificios	7 orificios	7 orificios	7 orificios
8 Orificios	8 Orificios	8 Orificios	8 Orificios
9 orificios	9 orificios	9 orificios	9 orificios
10 Orificios	10 Orificios	10 Orificios	10 Orificios
12 orificios	12 orificios	12 orificios	12 orificios

PERNO CORTICAL LCP 2.4 MM AUTORROSCANTE



PERNO CORTICAL LCP 2.4 MM AUTORROSCANTE			
ACERO		TITANIO	
06 mm	08 mm	06 mm	08 mm
10 mm	12 mm	10 mm	12 mm
14 mm	16 mm	14 mm	16 mm
18 mm	20 mm	18 mm	20 mm
22 mm	24 mm	22 mm	24 mm
26 mm	28 mm	26 mm	28 mm
30 mm		30 mm	

PERNO CORTICAL LCP 2.7 MM CABEZA 3.5 MM AUTORROSCANTE



PERNO CORTICAL LCP 2.7 MM CABEZA 3.5 MM AUTORROSCANTE			
ACERO		TITANIO	
08 mm	10 mm	08 mm	10 mm
12 mm	14 mm	12 mm	14 mm
16 mm	18 mm	16 mm	18 mm
20 mm	22 mm	20 mm	22 mm
24 mm	26 mm	24 mm	26 mm
28 mm	30 mm	28 mm	30 mm

PERNO CORTICAL LCP 3.5 MM AUTORROSCANTE

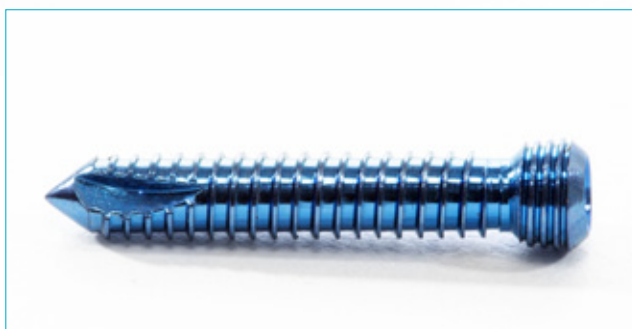
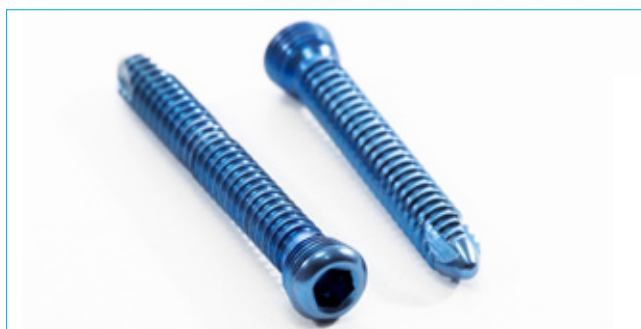

PERNO CORTICAL LCP 3.5 MM AUTORROSCANTE			
ACERO		TITANIO	
10 mm	12 mm	10 mm	12 mm
14 mm	16 mm	14 mm	16 mm
18 mm	20 mm	18 mm	20 mm
22 mm	24 mm	22 mm	24 mm
26 mm	28 mm	26 mm	28 mm
30 mm	32 mm	30 mm	32 mm
34 mm	36 mm	34 mm	36 mm
38 mm	40 mm	38 mm	40 mm
42 mm	44 mm	42 mm	44 mm
46 mm	48 mm	46 mm	48 mm
50 mm		50 mm	

PERNO CORTICAL LCP 4.9 MM AUTORROSCANTE



PERNO CORTICAL LCP 4.9 MM AUTORROSCANTE

ACERO			TITANIO		
16 mm	18 mm	20 mm	16 mm	18 mm	20 mm
22 mm	24 mm	26 mm	22 mm	24 mm	26 mm
28 mm	30 mm	32 mm	28 mm	30 mm	32 mm
34 mm	36 mm	38 mm	34 mm	36 mm	38 mm
40 mm	42 mm	44 mm	40 mm	42 mm	44 mm
46 mm	48 mm	50 mm	46 mm	48 mm	50 mm
52 mm	54 mm	56 mm	52 mm	54 mm	56 mm
58 mm	60 mm	62 mm	58 mm	60 mm	62 mm
64 mm	66 mm	68 mm	64 mm	66 mm	68 mm
70 mm	72 mm	74 mm	70 mm	72 mm	74 mm
76 mm	78 mm	80 mm	76 mm	78 mm	80 mm

PERNO ESPONJOSO LCP 4.9 MM



PERNO ESPONJOSO LCP 4.9 MM			
ACERO		TITANIO	
30 mm	35 mm	30 mm	35 mm
40 mm	45 mm	40 mm	45 mm
50 mm	55 mm	50 mm	55 mm
60 mm	65 mm	60 mm	65 mm
70 mm	75 mm	70 mm	75 mm
80 mm	85 mm	80 mm	85 mm
90 mm	95 mm	90 mm	95 mm
100 mm		100 mm	

PERNO CANULADO LCP 7.3 MM R25

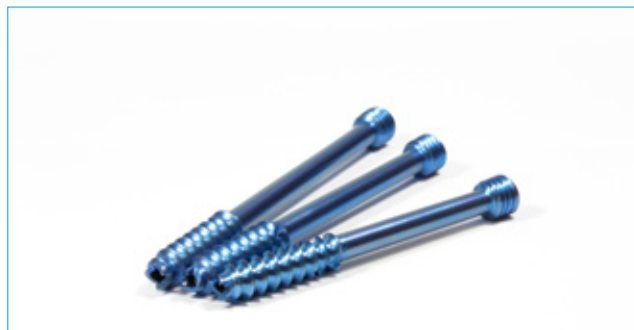

PERNO CANULADO LCP 7.3 MM R25			
ACERO		TITANIO	
60 mm	65 mm	60 mm	65 mm
70 mm	75 mm	70 mm	75 mm
80 mm	85 mm	80 mm	85 mm
90 mm	95 mm	90 mm	95 mm
100 mm	105 mm	100 mm	105 mm
110 mm	115 mm	110 mm	115 mm
120 mm		120 mm	

PERNO CANULADO LCP 7.3 MM ROSCA TOTAL

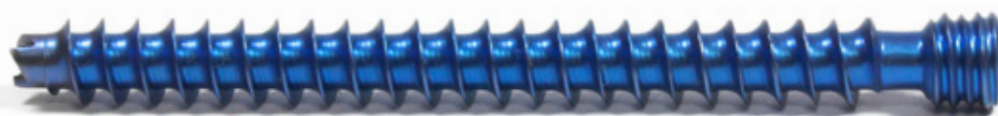

PERNO CANULADO LCP 7.3 MM ROSCA TOTAL

ACERO		TITANIO	
60 mm	65 mm	60 mm	65 mm
70 mm	75 mm	70 mm	75 mm
80 mm	85 mm	80 mm	85 mm
90 mm	95 mm	90 mm	95 mm
100 mm	105 mm	100 mm	105 mm
110 mm	115 mm	110 mm	115 mm
120 mm		120 mm	

TORNILLO CORTICAL 2.4 MM AUTORROSCANTE

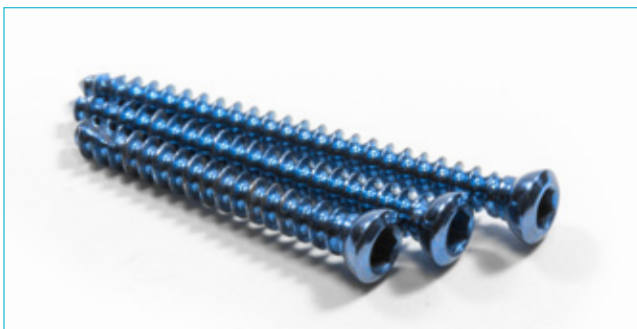

TORNILLO CORTICAL 2.4 MM AUTORROSCANTE			
ACERO		TITANIO	
06 mm	08 mm	06 mm	08 mm
10 mm	12 mm	10 mm	12 mm
14 mm	16 mm	14 mm	16 mm
18 mm	20 mm	18 mm	20 mm
22 mm	24 mm	22 mm	24 mm
26 mm	28 mm	26 mm	28 mm
30 mm		30 mm	

TORNILLO CORTICAL 3.5 MM TITANIO AUTORROSCANTE

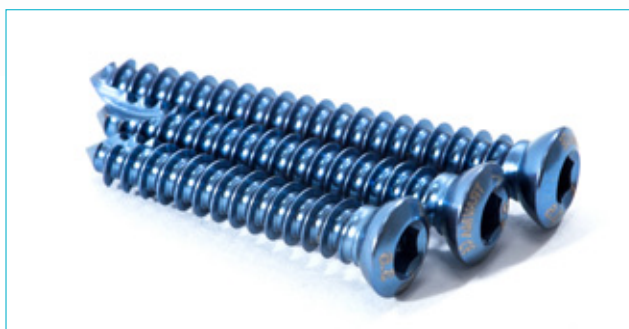
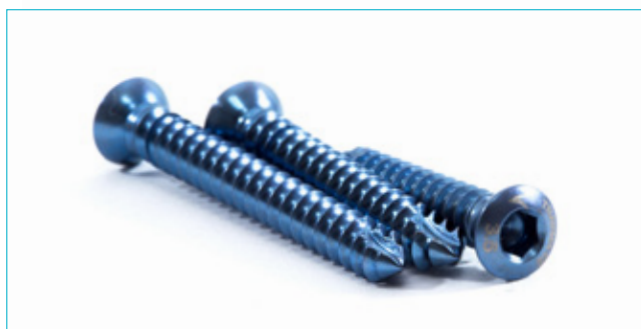

TORNILLO CORTICAL 3.5 MM AUTORROSCANTE			
TITANIO			
10 mm	12 mm	14 mm	16 mm
18 mm	20 mm	22 mm	24 mm
26 mm	28 mm	30 mm	32 mm
34 mm	36 mm	38 mm	40 mm
42 mm	44 mm	46 mm	48 mm
50 mm			

TORNILLO CORTICAL 4.5 MM TITANIO AUTORROSCANTE

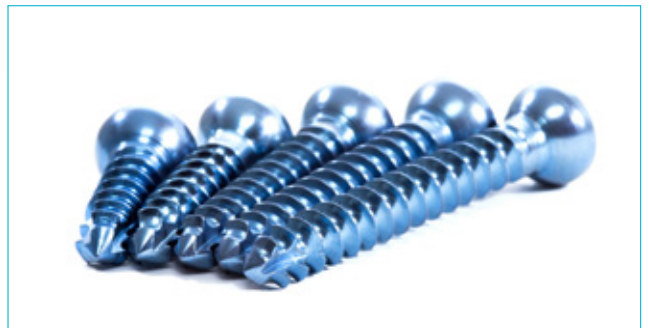

TORNILLO CORTICAL 4.5 MM AUTORROSCANTE

TITANIO

16 mm	18 mm	20 mm	22 mm
24 mm	26 mm	28 mm	30 mm
32 mm	34 mm	36 mm	38 mm
40 mm	42 mm	44 mm	46 mm
48 mm	50 mm	52 mm	54 mm
56 mm	58 mm	60 mm	62 mm
64 mm	66 mm	68 mm	70 mm
72 mm	74 mm	76 mm	78 mm
80 mm			

TORNILLO ESPONJOSO 4.0 MM ROSCA PARCIAL TITANIO

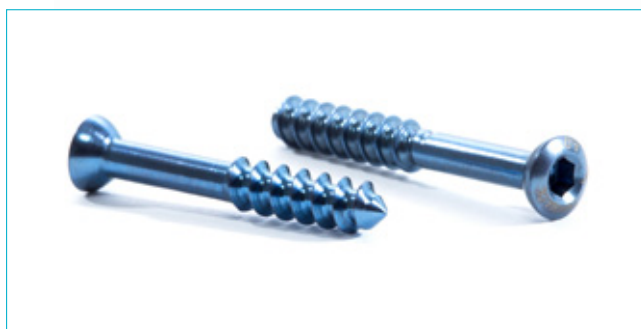

TORNILLO ESPONJOSO 4.0 MM ROSCA PARCIAL			
TITANIO			
10 mm	12 mm	14 mm	16 mm
18 mm	20 mm	22 mm	24 mm
26 mm	28 mm	30 mm	32 mm
34 mm	36 mm	38 mm	40 mm
42 mm	44 mm	46 mm	48 mm
50 mm			



Sabemos cuán importante es para usted el tiempo de entrega, por lo que nos comprometemos a tener un amplio stock para el surtido inmediato de sus solicitudes.



BROCA CORTA LISA (12.5 CM DE LARGO)		
2.0 mm	2.4 mm	2.7 mm
3.2 mm	3.5 mm	4.0 mm
4.5 mm	4.8 mm	
BROCA LARGA LISA (25 CM DE LARGO)		
2.0 mm	2.4 mm	2.7 mm
3.2 mm	3.5 mm	4.0 mm
4.5 mm	4.8 mm	

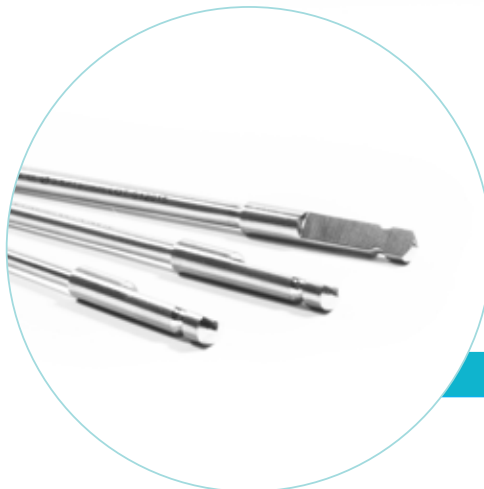

BROCA CORTA DE ANCLAJE RÁPIDO (12.5 CM DE LARGO)		
2.0 E-quick	2.4 E-quick	2.7 E-quick
3.2 E-quick	3.5 E-quick	4.0 E-quick
4.5 E-quick	4.8 E-quick	



BROCA CANULADA

Broca Canulada p/ tornillo
canulado 4.0 mm

Broca Canulada p/ tornillo
canulado 6.5 mm

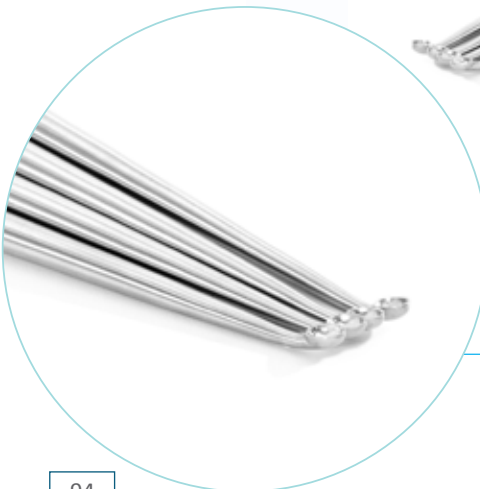

CUCHARILLAS

Cucharillas

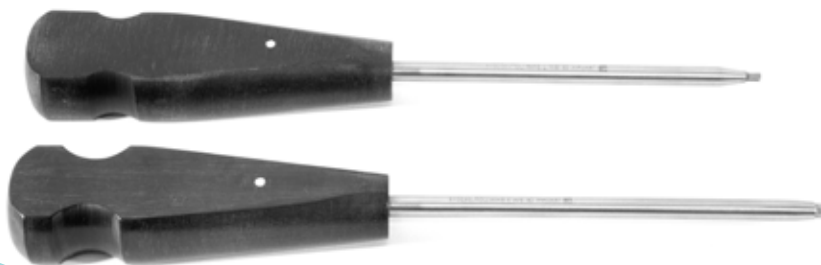

DESARMADOR HEXAGONAL

Desarmador Hexagonal
3.5/4.0 mm

Desarmador Hexagonal
4.5/6.5 mm

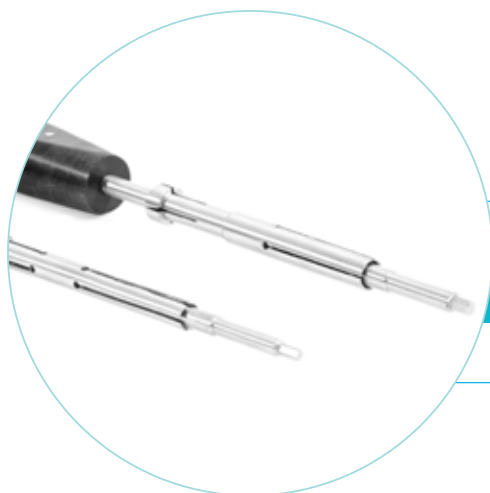

DESARMADOR HEXAGONAL CON SUJETADOR

Desarmador Hexagonal
3.5/4.0 mm con Sujetador

Desarmador Hexagonal
4.5/6.5 mm con Sujetador



DESARMADOR CON TORQUE

Desarmador Con Torque
2.4 mm 0.8N

Desarmador Con Torque
3.5 mm 1.5N

Desarmador Con Torque
4.9 mm 4.0N



DESARMADOR CANULADO

Desarmador Canulado 6.5 mm

Desarmador Canulado 4.0 mm



ELEVADOR DE PERIOSTIO RECTO

Elevador de Periostio Recto



ELEVADOR DE PERIOSTIO CURVO

Elevador de Periostio Curvo



GUÍAS LCP		
	Guía LCP 2.4 P/Broca 2.0 mm	Guía LCP 3.5 P/Broca 1.5 mm
	Guía LCP 3.5 P/Broca 2.7 mm	Guía LCP 3.5 P/Broca 3.2 mm
Guía LCP 4.9 P/Broca 2.0 mm	Guía LCP 4.9 P/Broca 3.5 mm	Guía LCP 4.9 P/Broca 4.0 mm
Guía LCP 7.3 P/Broca 5.0 mm		



GUÍA PARA CLAVO CENTROMEDULAR CON OLIVA		
	Guía para Clavo Centromedular con Oliva	



MACHUELOS		
	Machuelo Canulado 4.0 mm	Machuelo Canulado 6.5 mm
	Machuelo 2.7 mm con Mango en T	Machuelo 3.5 mm con Mango en T
	Machuelo 4.0 mm con Mango en T	Machuelo 4.5 mm con Mango en T
	Machuelo 6.5 mm con Mango en T	

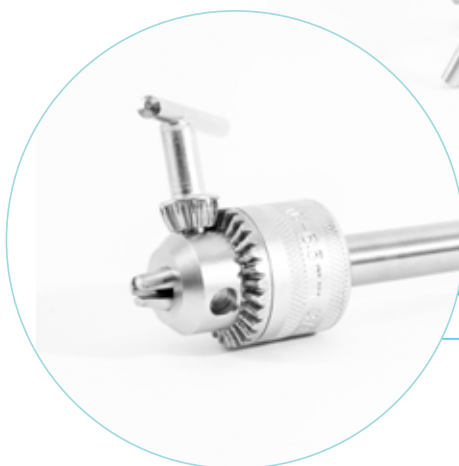

MANERAL EN T CON CHUCK		
	Maneral En T Con Chuck	

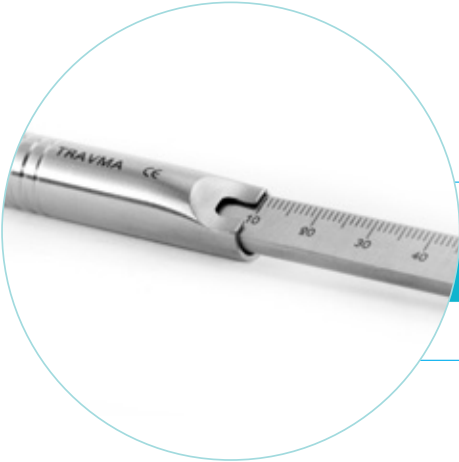

MEDIDORES DE PROFUNDIDAD

Medidor de Profundidad
Mini 30 mm

Medidor de Profundidad
Chico 60 mm

Medidor de Profundidad
Grande 80 mm

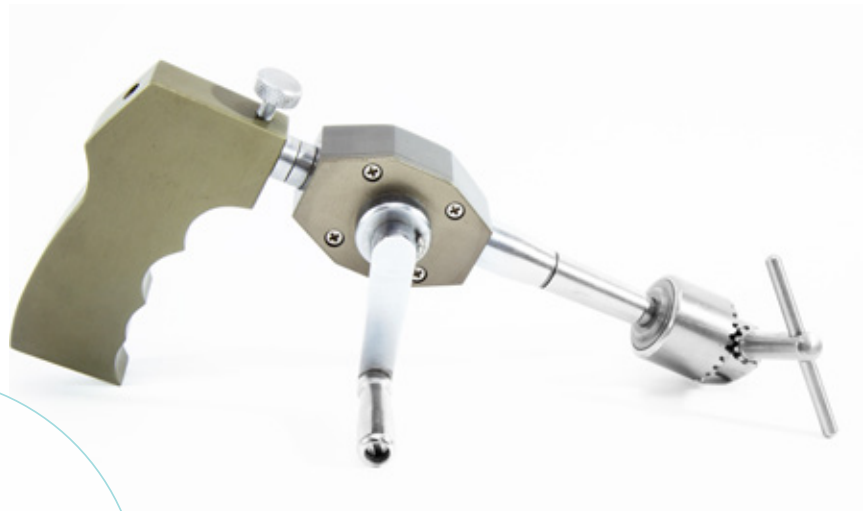

PERFORADOR MANUAL

Perforador Manual



MARTILLOS

	Martillo Chico 300 grs sin Extremo Nylon	Martillo Chico 300 grs con Extremo Nylon
	Martillo Mediano 600 grs sin Extremo Nylon	Martillo Mediano 600 grs con Extremo Nylon
	Martillo Grande 900 grs sin Extremo Nylon	Martillo Grande 900 grs con Extremo Nylon



MARTILLO CON MANGO

	Martillo con Mango 300 grs	Martillo con Mango 600 grs
	Martillo con Mango 900 grs	



OSTEOTOMOS CON MANGO

Osteotomo con Mango 6*240 mm	Osteotomo con Mango 8*240 mm	Osteotomo con Mango 10*240 mm
Osteotomo con Mango 12*240 mm	Osteotomo con Mango 15*240 mm	Osteotomo con Mango 20*240 mm
Osteotomo con Mango 25*240 mm	Osteotomo con Mango 30*240 mm	

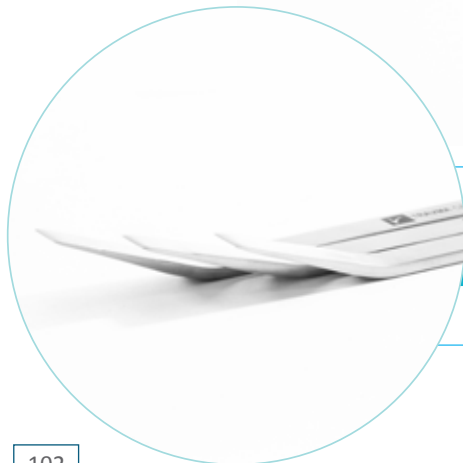

OSTEOTOMOS RECTOS O CURVOS

Osteotomo Mini 4 mm	Osteotomo Mini 6 mm	Osteotomo Mini 8 mm
Osteotomo Mini 10 mm	Osteotomo Mini 12 mm	Osteotomo Mini 14 mm



PINZAS TIPO CAMPO

Pinza tipo Campo con
Cremallera 13 cm



MINI PINZAS CORTA ALAMBRE

Mini Pinza Cortadora de
Alambre hasta 1.2 mm



PINZAS CORTA ALAMBRE

Pinza Cortadora de Alambre
hasta 3.0 mm



PINZAS CORTA ALAMBRE (BAILARINA)

Pinza Cortadora de Alambre
hasta 6.0 mm



PINZAS DE LOWMAN

Pinza de Lowman
Chica 15 cm

Pinza de Lowman
Mediana 17 cm

Pinza de Lowman
Grande 20 cm



PINZAS LANE

Pinza Lane con Cremallera
21 cm

Pinza Lane con Cremallera
24 cm

Pinza Lane con Cremallera
33 cm

Pinza Lane con Cremallera
45 cm



RIMAS

Rima para Prótesis de Thompson

Rima para Protésis de Lazcano

RIMAS		
	Rima para Prótesis de Thompson	
	Rima para Protésis de Lazcano	



SIERRA DE GIGLI

Sierra de Gigli 30 cm

Sierra de Gigli 50 cm

Sierra de Gigli 70 cm

Mango para Sierra de Gigli

SIERRA DE GIGLI		
	Sierra de Gigli 30 cm	Sierra de Gigli 50 cm
	Sierra de Gigli 70 cm	Mango para Sierra de Gigli



TRISCADORES PEQUEÑOS
FRAGMENTOS Y RECONSTRUCCIÓN

Triscadores Pequeños
Fragmentos y
Reconstrucción (par)

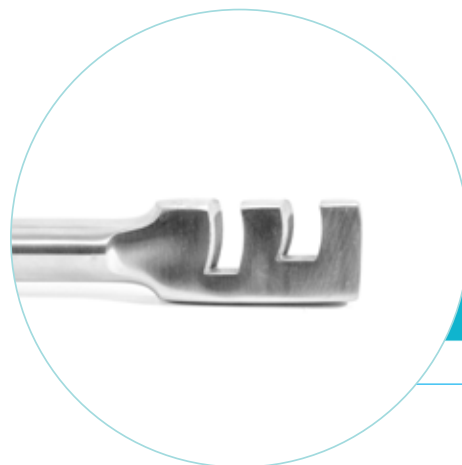

TRISCADORES PEQUEÑOS
FRAGMENTOS Y RECONSTRUCCIÓN

Triscadores Grandes
Fragmentos (par)



SEPARADORES DE HOFFMAN

Separador Hoffman 8 mm (Par)	Separador Hoffman 10 mm (Par)
Separador Hoffman 12 mm (Par)	Separador Hoffman 14 mm (Par)
Separador Hoffman 16 mm (Par)	Separador Hoffman 18 mm (Par)
Separador Hoffman 24 mm (Par)	Separador Hoffman 44 mm (Par)



SEPARADOR DE BENNET

Separador de Bennet (par)



SEPARADOR DE GARRA

Separador de Garra 25X7 3 Dientes

Separador e Garra 25X7 4 Dientes



SEPARADOR DE GARRA SEN MILLER

Separador de Garra Sen Miller



TUBO PARA ESTERILIZAR KIRSHNER

Tubo para Esterilizar Kirshner 25 cm



CAJA PARA ESTERILIZAR PERFORADOR

Caja para Esterilizar
Perforador

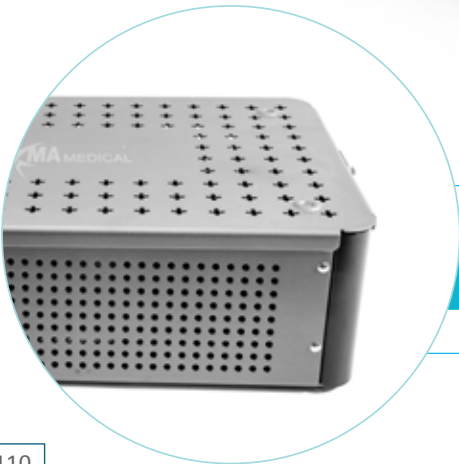

CAJA PARA ESTERILIZAR SIMPLE

Caja para Esterilizar Simple

CAJAS

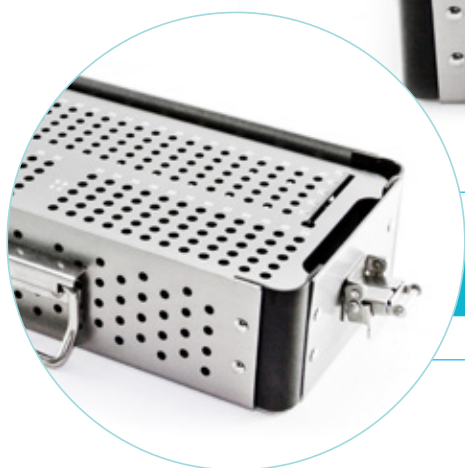

CAJA TORNILLERA CON RACK 3.5/4.0

Caja Tornillera con
Rack 3.5/4.0



CAJA TORNILLERA CON RACK 4.5/6.5

Caja Tornillera con
Rack 4.5/6.5

KIT DE RIMAS FLEXIBLES

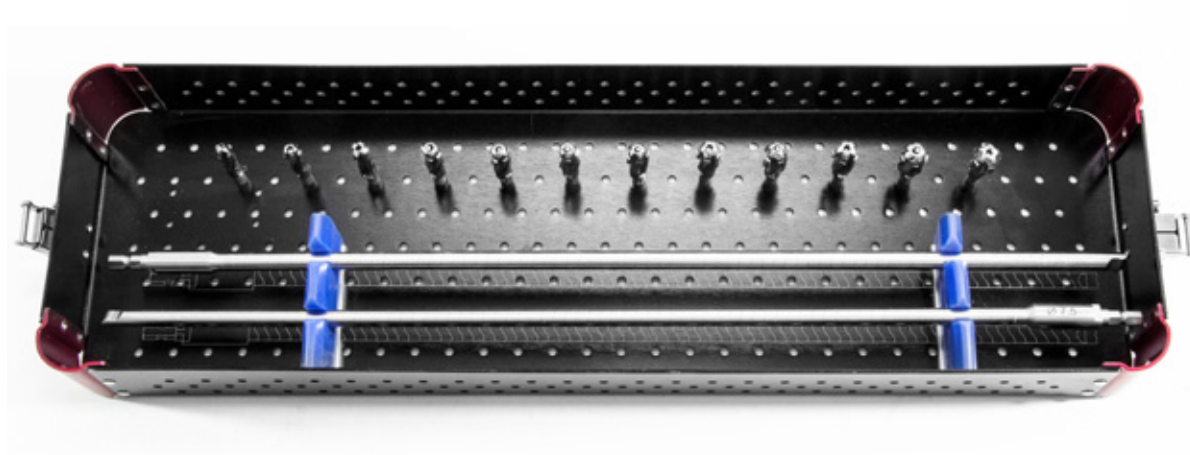

KIT DE RIMAS FLEXIBLES		
1 Vástago Flexible 7.5	1 Vástago Flexible 8.5	
1 Punta de Rima 7.5	1 Punta de Rima 8.0	1 Punta de Rima 8.5
1 Punta de Rima 9.0	1 Punta de Rima 9.5	1 Punta de Rima 10.0
1 Punta de Rima 10.5	1 Punta de Rima 11.0	1 Punta de Rima 11.5
1 Punta de Rima 12.0	1 Punta de Rima 12.5	1 Punta de Rima 13.0
1 Caja para Esterilizar Set de Rimas		

KIT DE INSTRUMENTAL BÁSICO PARA TORNILLOS CANULADOS



KIT DE INSTRUMENTAL BÁSICO PARA TORNILLOS CANULADOS 4.0 MM		
1 Desarmador Canulado 4.0 mm	1 Machuelo Canulado 4.0 mm	1 Broca Canulada para Tornillo 4.0 mm
1 Alambre Guía 1.2 mm para Canulado 4.0 mm		

KIT DE INSTRUMENTAL BÁSICO PARA TORNILLOS CANULADOS 6.5 MM		
1 Desarmador Canulado 6.5 mm	1 Machuelo Canulado 6.5mm	1 Broca Canulada para Tornillo 6.5 mm
1 Alambre Guía 1.6 mm para Canulado 6.5 mm		

KIT DE INSTRUMENTAL PARA CANULADOS 4.0 MM

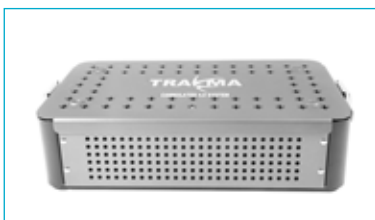
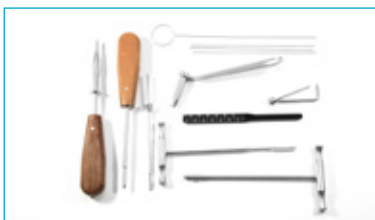

KIT DE INSTRUMENTAL PARA CANULADOS 4.0 MM		
1 Avellanador Canulado 4.0 mm	1 Machuelo Canulado 4.0 mm	1 Broca Canulada para Tornillo 4.0 mm
1 Alambre Guía para Canulado 4.0 mm	1 Medidor Guía para Canulado 4.0 mm	1 Desarmador Canulado 4.0 mm
1 Desarmador Hexagonal 3.5/4.0 mm	1 Guía de Broca c/Camisa para 4.0 mm	1 Caja para Esterilizar Kit de Canu- lado 6.5 mm

KIT DE INSTRUMENTAL PARA CANULADOS 6.5 MM

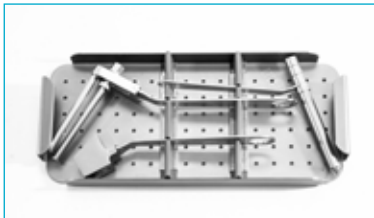

KIT DE INSTRUMENTAL PARA CANULADOS 6.5 MM		
1 Avellanador Canulado 6.5 mm	1 Machuelo Canulado 6.5 mm	1 Broca Canulada para Tornillo 6.5 mm
1 Alambre Guía para Canulado 6.5 mm	1 Medidor Guía para Canulado 6.5 mm	1 Desarmador Canulado 6.5 mm
1 Desarmador Hexagonal 4.5/6.5 mm	1 Guía de Broca C/Camisa para 6.5 mm	1 Multiguía para 6.5 mm
1 Guía con Espaciador para 6.5 mm	1 Caja para Esterilizar Kit de Canulado 6.5 mm	

KIT PARA COLOCACIÓN Y EXTRACCIÓN DE GRAPAS



KIT PARA COLOCACIÓN Y EXTRACCIÓN DE GRAPAS

1 Aplicador para Grapas

1 Impactador para Grapas

1 Extractor para Grapas

KIT PARA COLOCACIÓN Y EXTRACCIÓN DE THOMPSON

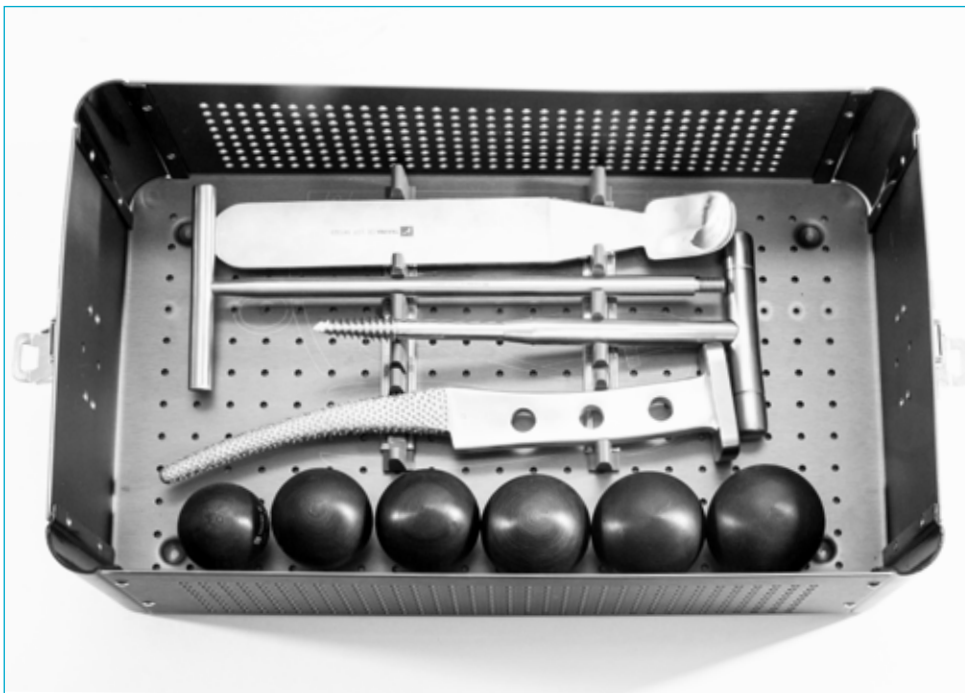
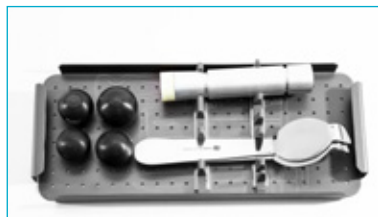

KIT PARA COLOCACIÓN Y EXTRACCIÓN DE THOMPSON		
1 Extractor de Cabeza Femoral en Cuchara	1 Extractor de Cabeza Femoral en Espiral	1 Mallete De Aluminio
1 Par de Separador de Bennet	1 Rima De Thompson	1 Set de Probadores de Cabeza Femoral
	1 Caja para Esterilizar Thompson	

KIT PARA COLOCACIÓN DE PLACAS ANGULADAS

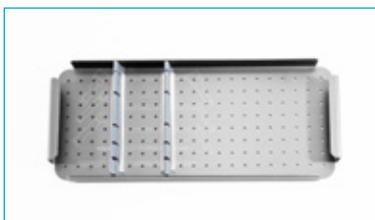

KIT PARA COLOCACIÓN DE PLACAS ANGULADAS		
1 Escoplo Guía para Placas Anguladas	1 Diapazón	1 Impactador Cónico para Placas Anguladas
1 Porta Placas 130°	1 Porta Placas 95°	1 Caja para Esterilizar Simple

KIT DE INSTRUMENTAL PARA CERCLAJE

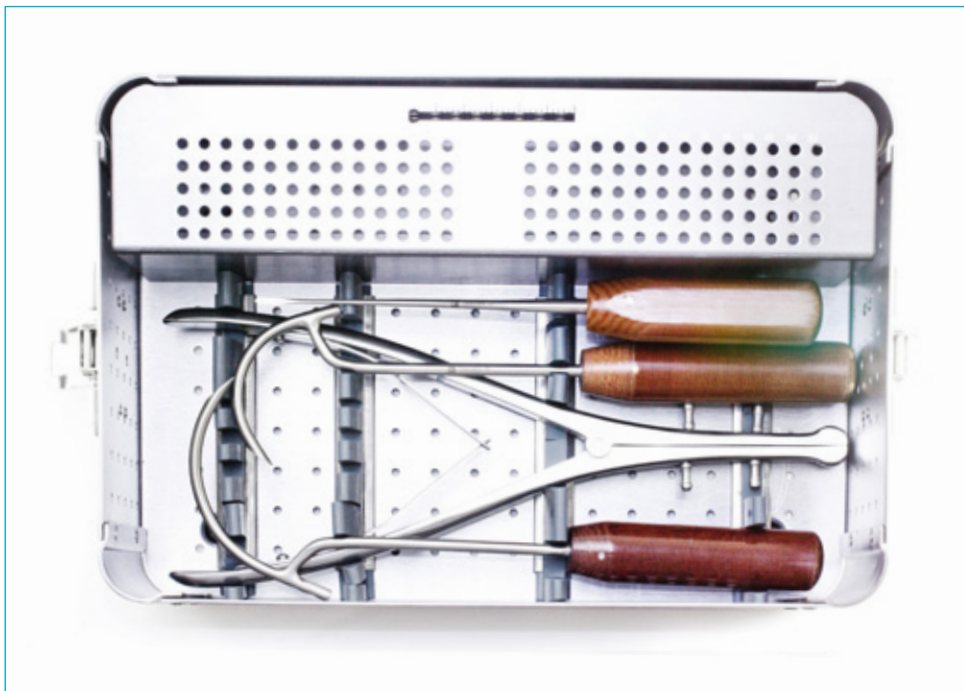
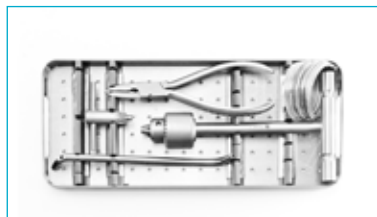

KIT DE INSTRUMENTAL PARA CERCLAJE		
1 Pasa Alambre Curvo Mediano	1 Pasa Alambre Curvo Grande	1 Pasa Alambre Recto
1 Pasa Hilo	1 Iniciador P/Alambre	1 Pinza Torcedora de Alambre
1 Alicate Simple Chico	1 Alicate Simple Grande	1 Maneral en T Con Chuck
1 Caja para Instrumental de Cerclaje		

KIT PARA MINI FRAGMENTOS

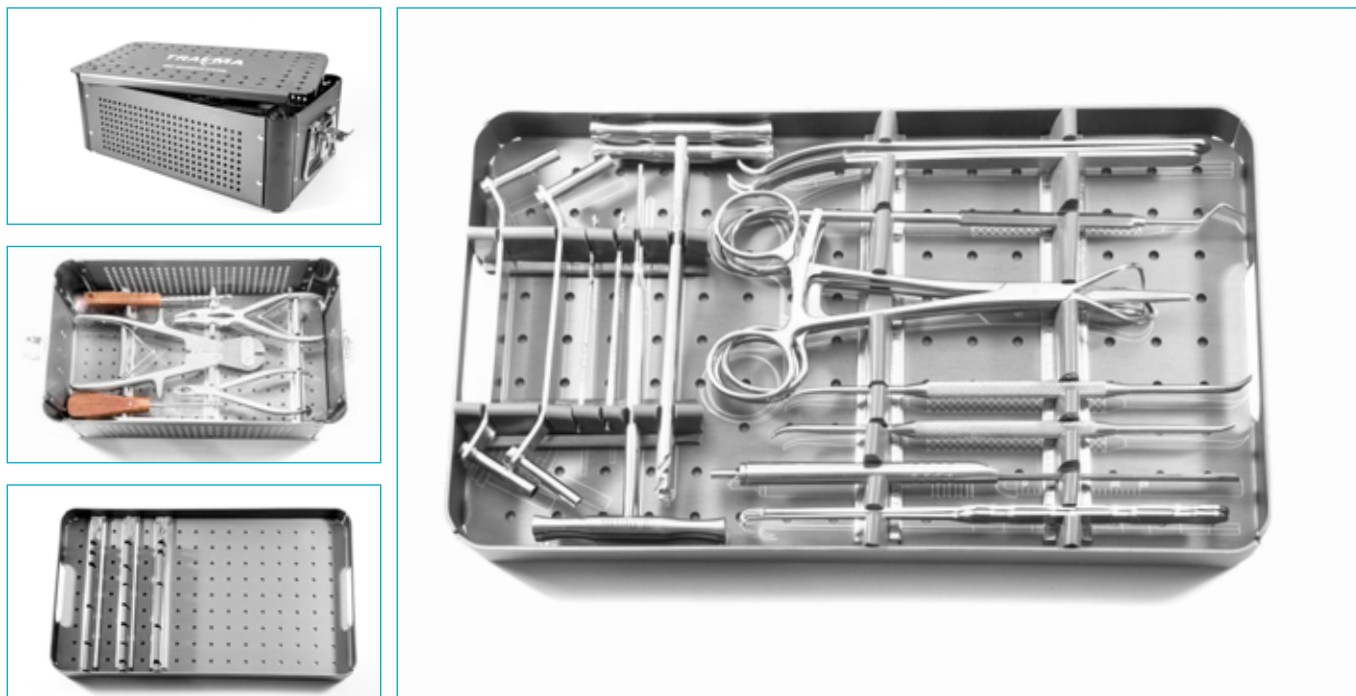

KIT PARA MINIFRAGMENTOS

1 Pinza Gubia Curva 17 cm	2 Desarmador Hexagonal 2.4 mm	1 Pinza Corta Alambre hasta 3.0 mm	1 Pinza Sujetadora de Miniplacas
1 Par Triscadores P/Miniplacas	1 Guía Neutra P/Broca 1.5 mm y Machuelo 2.0 mm	1 Guía Neutra P/Broca 2.0 mm y Machuelo 2.7 mm	2 Broca 2.0 mm
2 Broca 1.5 mm	1 Avellanador 5.0 P/2.7 mm	1 Avellanador 4.5 P/2.4 mm	1 Machuelo 2.0 mm
1 Machuelo 2.7 mm	1 Separador De Hoffman 6 mm (Pieza)	1 Separador de Hoffman 8 mm (Pieza)	1 Separador de Hoffman 12 mm (Pieza)
1 Disector de Nervio	1 Pinza Tipo Campo C/Cremallera 14 cm	1 Pinza Tipo Campo Multidentada C/Cremallera 14 cm	1 Pinza Mosquito Recta
1 Elevador de Periostio Recto & Curvo 5 mm	1 Elevador de Periostio Recto & Curvo 3 mm	1 Mini Medidor de Profundidad 40 mm	1 Par de Mini Separadores
1 Pinza Sujetadora de Tornillos	1 Mini Tornillera 1.5/2.0/2.4 Ó 2.7	1 Caja para Esterilizar Kit Minifragmentos	

KIT DE INSTRUMENTAL PEQUEÑOS FRAGMENTOS

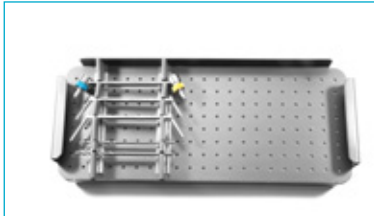

KIT DE INSTRUMENTAL PEQUEÑOS FRAGMENTOS

2 Broca 2.5 mm	2 Broca 3.2 mm	1 Guía de Broca 3.5/4.0 mm	1 Guía de Broca 2.5/3.2 mm
1 Guía de Broca Excentrica Neutra 2.5 mm	1 Desarmador Hexagonal 3.5/4.0 mm	1 Avellanador 3.5/4.0	1 Medidor de Profundidad Chico 60 mm
1 Machuelo 3.5 mm con Mango en T	1 Machuelo 4.0 mm con Mango en T	1 Extractor de Tornillo Barrido 3.5/4.0 mm	1 Elevador de Periostio Recto
1 Elevador de Periostio Curvo	2 Pinza Autocentrante 180 mm	1 Pinza de Reduccion Multidentada 180 mm	1 Pinza tipo Campo 180 mm
	1 Triscadores Pequeños Fragmentos (par)	1 Caja para Esterilizar Pequeños Fragmentos	

KIT DE INSTRUMENTAL GRANDES FRAGMENTOS

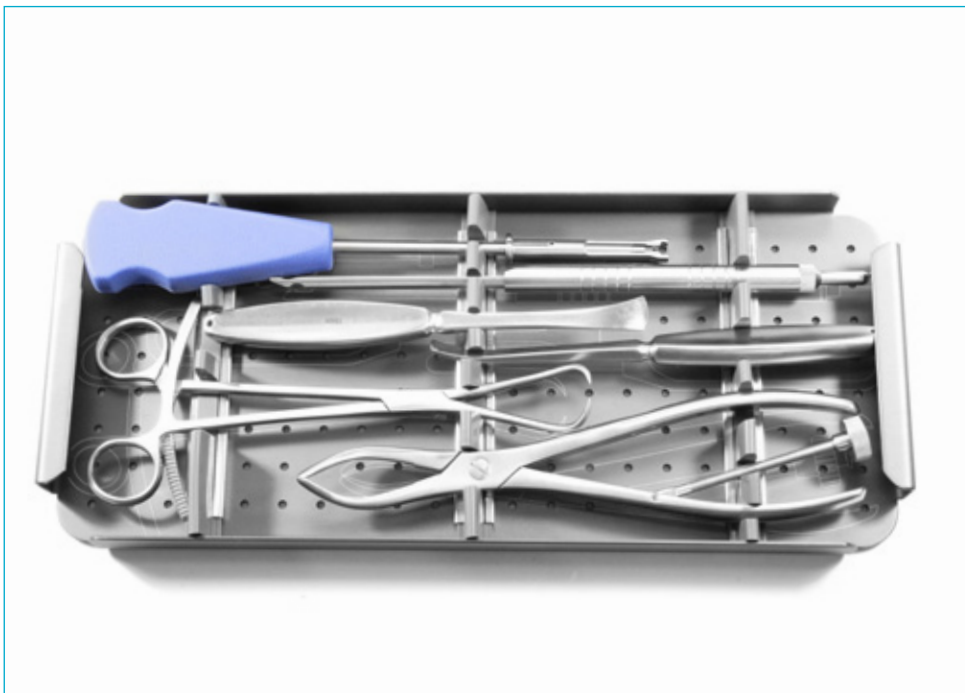
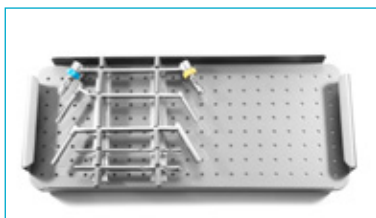

KIT DE INSTRUMENTAL GRANDES FRAGMENTOS		
1 Guía de Broca Excéntrica Neutra 3.2 mm	1 Guía de Broca 3.2/4.5 mm	1 Guía de Broca 4.5/6.5 mm
2 Broca 3.2 mm	2 Broca 4.5 mm	2 Pinza Autocentrante 220 mm
1 Pinza De Reducción Multidentada 220 mm	1 Pinza tipo Campo 220 mm	1 Medidor de Profundidad Grande 80 mm
1 Desarmador Hexagonal 4.5/6.5 mm	1 Extractor de Tornillo Barrido 4.5/6.5 mm	1 Elevador de Periostio Recto
1 Elevador de Periostio Curvo	1 Machuelo 4.5 mm con Mango en T	1 Machuelo 6.5 mm con Mango en T
1 Triscadores Grandes Fragmentos (par)	1 Caja para Esterilizar Grandes Fragmentos	

KIT DE INSTRUMENTAL PARA PLACAS DHS-DCS



KIT DE INSTRUMENTAL PARA PLACAS DHS-DCS

1 Guía de Broca 4.5/6.5 mm	1 Guía de Broca 3.2/4.5 mm	1 Guía de Broca Excéntrica Neutra 3.2 mm	1 Broca 3.2 mm
1 Machuelo 4.5 mm con Mango en T	1 Broca 4.5 mm	1 Machuelo 6.5 mm con Mango en T	1 Maneral en T para Instrumental DHS/DCS
1 Guía Fija para Placas 135°	1 Guía Fija para Placas 95°	1 Desarmador Hexagonal 4.5/6.5 mm	1 Machuelo para Tornillo Deslizante 12.7 mm
1 Desarmador con T para Tornillo Deslizante 12.7 mm	1 Impactador para Placas DHS/DCS	1 Rima para DHS/DCS	1 Alambre Guía 2.5 mm con Sujetador
1 Medidor de Profundidad 90 mm	1 Medidor Guía de Profundidad para Alambre	1 Alambre Guía para DHS/DCS	1 Caja para Esterilizar DHS/DCS

KIT DE INSTRUMENTAL PARA PLACAS BLOQUEADAS 2.4 MM

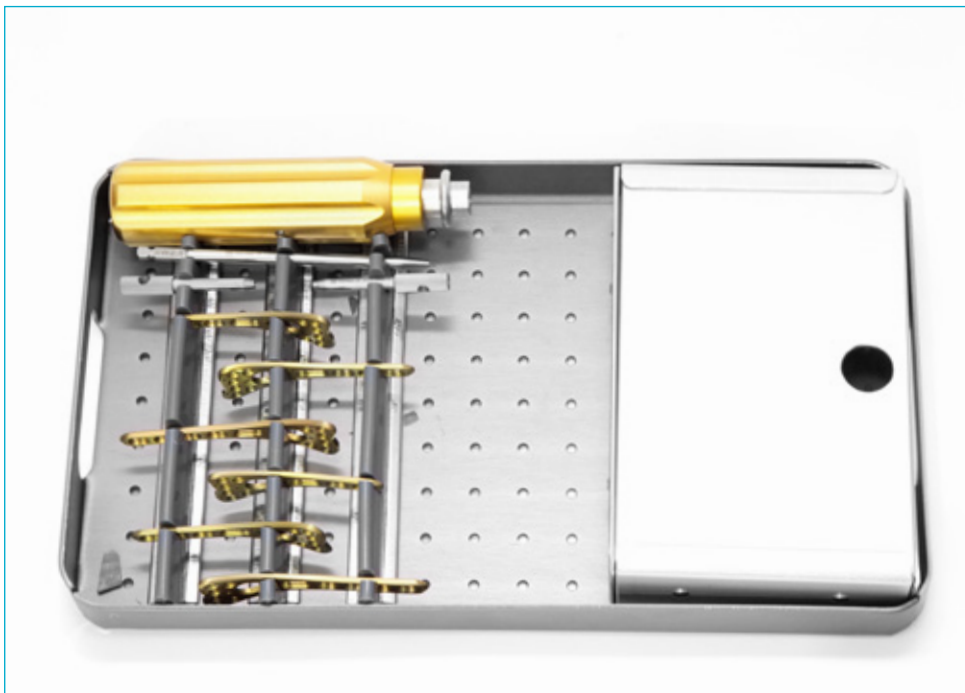
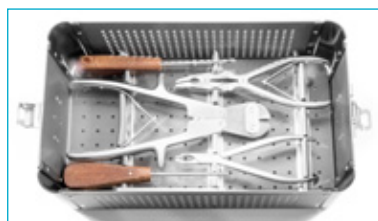
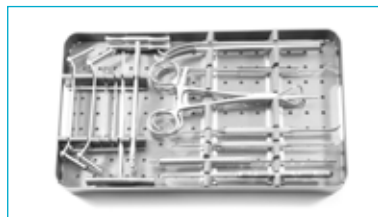

KIT DE INSTRUMENTAL PARA PLACAS BLOQUEADAS 2.4 MM

1 Pinza Gubia Curva 17 cm	2 Desarmador Hexagonal 2.4	1 Pinza Corta Alambre hasta 3.0 mm	1 Pinza Sujetadora de Miniplacas
1 Par Triscadores P/Miniplacas	1 Guía Neutra P/Broca 1.5 y machuelo 2.0 mm	1 Guía Neutra P/Broca 2.0 mm y Machuelo 2.7 mm	2 Broca 2.0 mm
2 Broca 1.5 mm	1 Avellanador 5.0 P/2.7 mm	1 Avellanador 4.5 P/2.4 mm	1 Machuelo 2.0 mm
1 Machuelo 2.7 mm	1 Separador de Hoffman 6 mm (Pieza)	1 Separador de Hoffman 8 mm (Pieza)	1 Separador de Hoffman 12 mm (Pieza)
1 Disector de Nervio	1 Pinza tipo Campo C/Cremallera 14 cm	1 Pinza tipo Campo Multidentada C/Cremallera 14 cm	1 Pinza Mosquito Recta
1 Elevador de Periostio Recto y Curvo 5 mm	1 Elevador de Periostio Recto y Curvo 3 mm	1 Mini Medidor de Profundidad 40 mm	1 Par de Mini Separadores
1 Pinza Sujetadora de Tornillos	1 Mini Tornillera 1.5/2.0/2.4 ó 2.7	1 Caja para Esterilizar Kit Minifragmentos	
1 Desarmador con Torque 2.4 mm	2 guías LCP 2.4 mm		

KIT DE INSTRUMENTAL PARA PLACAS BLOQUEADAS 3.5 MM

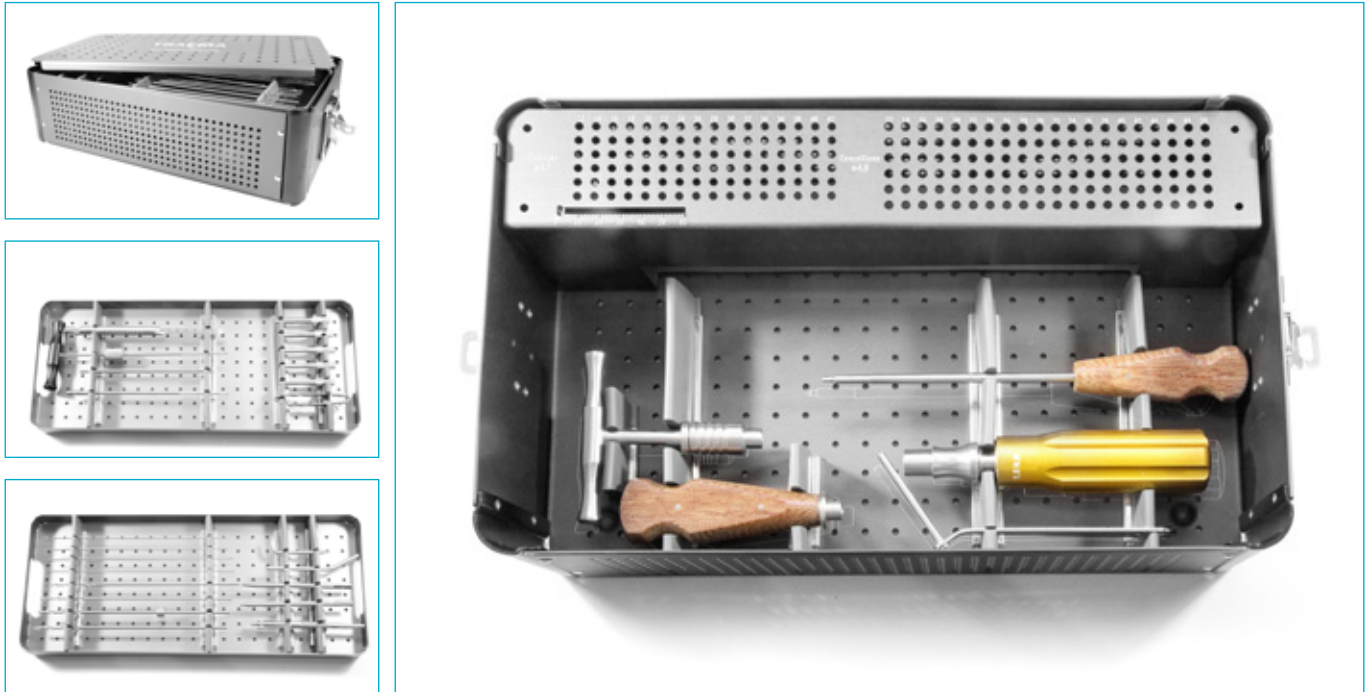

KIT DE INSTRUMENTAL PARA PLACAS BLOQUEADAS 3.5 MM

1 Desarmador con Torque 1.5 M.N 3.5/4.0 mm	1 Desarmador con Punta Expansiva 3.5/4.0 mm	1 Desarmador Hexagonal 3.5/4.0 con Sujetador de Tornillo	1 Mango de Madera con Acople Rápido
2 Punta Hexagonal 3.5/4.0 mm	1 Machuelo LCP E-Quick 3.5 mm	1 Machuelo LCP E-Quick 4.0 mm	2 Guía LCP 3.5 para Placas Bloqueadas
1 Medidor de Profundidad Chico 60 mm	3 Alambre Guía 1.6 mm con Cuerda en Punta	3 Alambre de Kirshner 1.6 mm	5 Brocas 3.2 mm Graduada
3 Brocas 2.4 mm	1 Guía de Broca 2.5/3.2 mm	1 Maneral en T con Acople Rápido	1 Extractor de Tornillo Barrido 3.5/4.0 mm
1 Mini Llave Allen P/Tope de Broca	1 Mini Pinza Sujetadora de Tornillos	1 Llave tipo Allen P/Guía LCP	1 Machuelo Con T P/LCP 3.0 mm
1 Caja Para Esterilizar 3.5 mm			

KIT DE INSTRUMENTAL PARA PLACAS BLOQUEADAS 4.9 MM



KIT DE INSTRUMENTAL PARA PLACAS BLOQUEADAS 4.9 MM

1 Desarmador con Torque 4.9 mm	1 Desarmador con Punta Expansiva 4.5/6.5 mm	1 Desarmador Hexagonal 4.5/6.5 mm con Sujetador de Tornillo	1 Mango de Madera con Acople Rápido
2 Punta Hexagonal 4.9 mm	2 Machuelo LCP E-Quick 4.9 mm	3 Guía LCP 4.9 mm para Placas Bloqueadas	1 Medidor de Profundidad Grande 90 mm
3 Alambre Guía 2.0 mm con Cuerda en Punta	3 Alambre de Kirshner 2.0 mm	5 Broca 4.3 mm Graduada	3 Broca 3.2 mm
1 Guía de Broca 3.2/4.5 mm	1 Maneral en T con Acople Rápido	1 Extractor de Tornillo Barrido 4.5/6.5 mm	1 Mini Llave Allen P/ Tope de Broca
1 Mini Pinza Sujetadora de Tornillos	1 Llave tipo Allen P/Guía LCP	1 Machuelo con T P/LCP 4.0 mm	1 Caja para Esterilizar LCP 4.9 mm
1 Machuelo 4.5 mm E-Quick			

KIT DE INSTRUMENTAL PARA MAXILOFACIAL

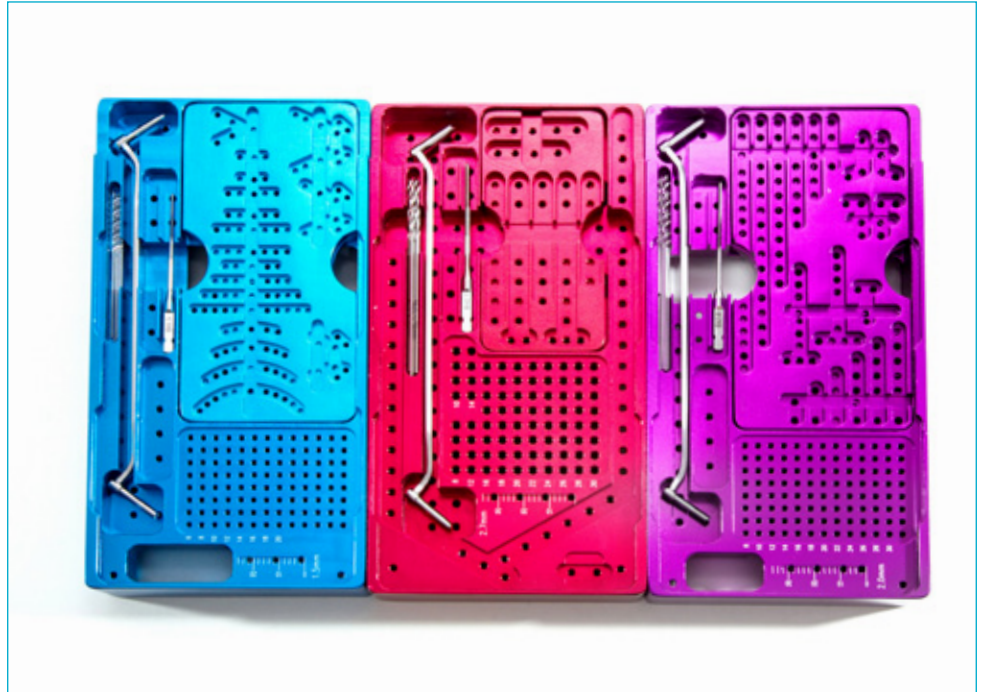
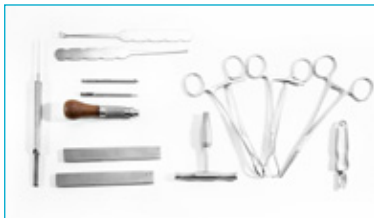
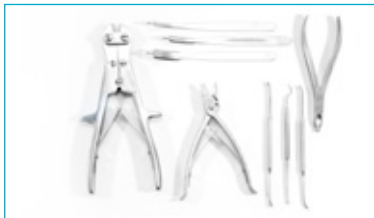

KIT DE INSTRUMENTAL PARA MAXILOFACIAL

1 Plaquera para 1.5 mm	1 Machuelo Acople Rápido para 1.5 mm	1 Guía de Broca 1.1/1.5 mm	4 Broca 1.0 mm
1 Plaquera para 2.0 mm	1 Machuelo Acople Rápido para 2.0 mm	1 Guía de Broca 1.5/2.0 mm	4 Broca de 1.5 mm
1 Plaquera para 2.7 mm	1 Machuelo Acople Rápido para 2.7 mm	1 Guía de Broca 2.0/2.7 mm	4 Broca de 2.0 mm
1 Par de Mini Triscadores	1 Mango Metálico para Acople Rápido	1 Mini Pinza Sujetadora de Tornillos	1 Pinza Sujetadora de Placas
1 Pinza Cortadora de 3.0 mm	1 Pinza Dobladora / Avellanadora de Placas	1 Pinza tipo Campo Punta Afilada	1 Pinza tipo Campo Dentada Curva Abierta
1 Pinza tipo Campo Dentada Recta Cerrada	1 Mango de Madera Acople Rápido	1 Punta Hexagonal con Sujetador de Tornillos	1 Mini Avellanador
1 Mini Medidor de Profundidad 40 mm	2 Mini Separadores tipo Garra	1 Gancho Disector	1 Elevador de Periostio Doble Punta Recta y Curva 3 mm
1 Elevador de Periostio Doble Punta Recta y Curva 5 mm	1 Separador de Hoffman 6 mm	1 Separador de Hoffman 8 mm	1 Separador de Hoffman 12 mm
1 Caja para Esterilizar Maxilofacial			

KIT DE INSTRUMENTAL PARA CLAVO TEN

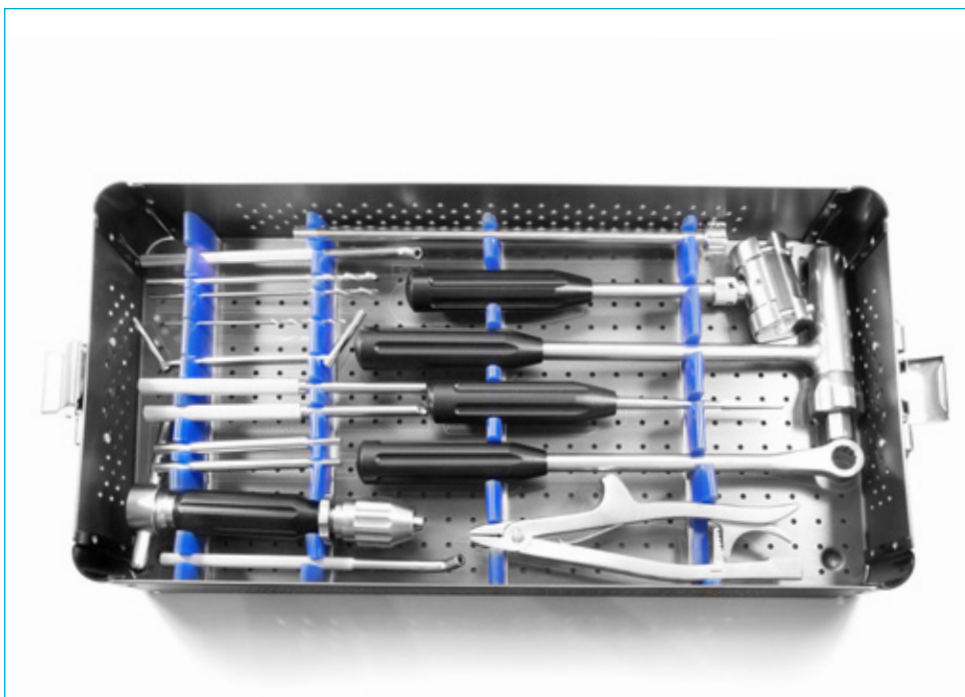
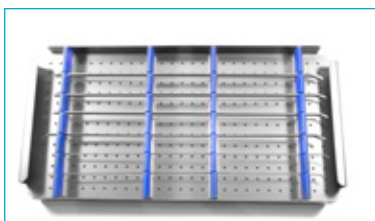

KIT DE INSTRUMENTAL PARA CLAVO TEN		
1 Punzón Iniciador Recto	1 Punzón Iniciador Curvo	1 Cortador para Ten
1 Alicates de Extracción para Ten	1 Martillo de 350 con Extremo de Nylon	1 Maneral en T con Chuck
1 Impactador para T Recto	1 Impactador para T Curvo	

EQUIPO DE CLAVO CENTROMEDULAR

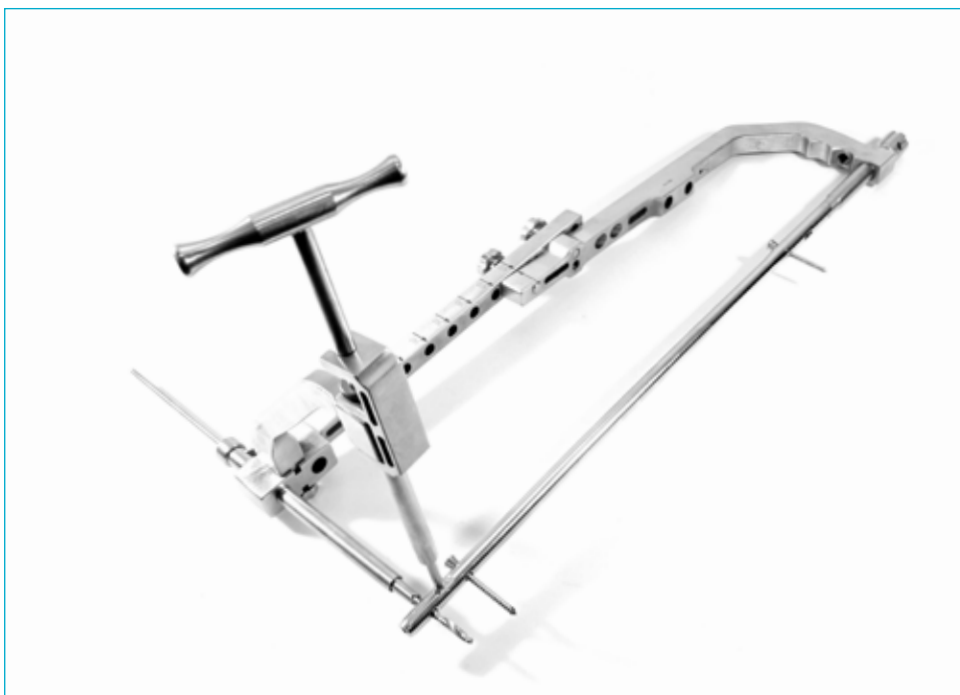
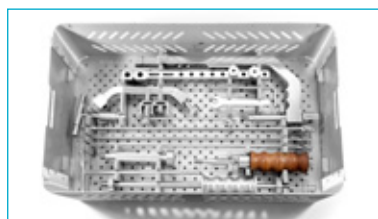
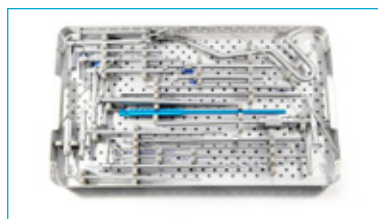

EQUIPO DE CLAVO CENTROMEDULAR

Equipo de Clavo
Centromedular para Húmero

Equipo de Clavo
Centromedular para Tibia

Equipo de Clavo
Centromedular para Fémur

PERFORADOR ELÉCTRICO CANULADO CHUCK DESMONTABLE



Perforador Eléctrico Canulado Chuck Desmontable

MINI PERFORADOR CANULADO



Mini Perforador Canulado

SIERRA OSCILANTE ELÉCTRICA



Sierra Oscilante Eléctrica

SIERRA CORTA YESO



Sierra Corta Yeso

ACCESORIOS PARA EQUIPO DE PODER

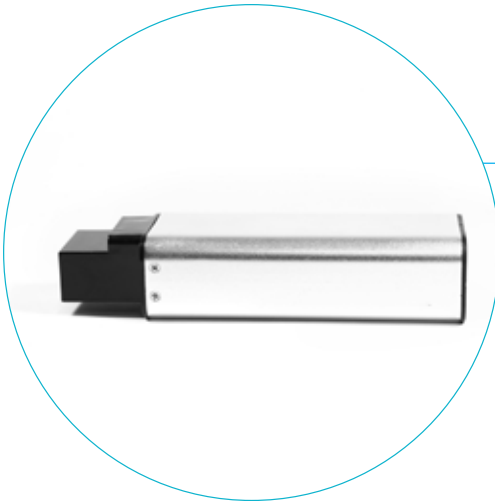

Batería Estándar



Mini Batería

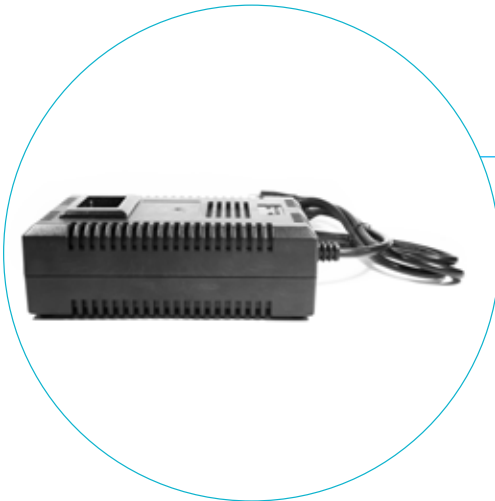

Cargador Para Baterías

ACCESORIOS PARA EQUIPO DE PODER

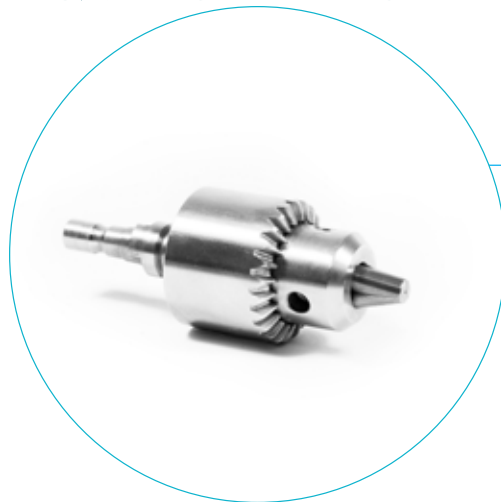

Mandril Para Perforador

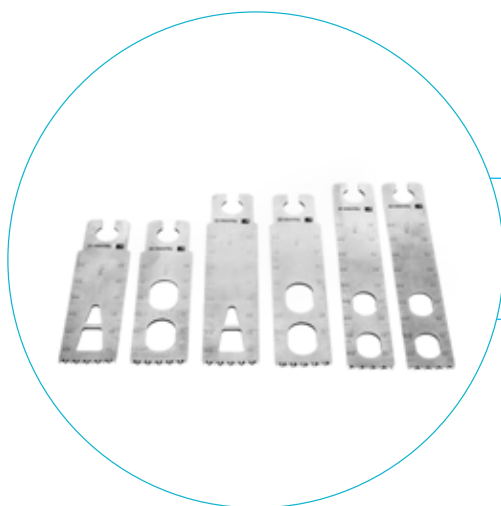

Hoja Sierra Oscilante



Hoja para Sierra Yeso Striker



Hoja para Sierra Yeso Estándar

